

# ENGLISH

## User manual



**Table of contents:**

1. PRECAUTIONS AND SAFETY MEASURES .....	2
1.1. Preliminary instructions .....	2
1.2. During use .....	3
1.3. After use .....	3
1.4. Definition of Measurement (Overvoltage) category .....	3
2. GENERAL DESCRIPTION .....	4
2.1. Measuring average values and TRMS values .....	4
2.2. Definition of true root mean square value and Crest factor .....	4
3. PREPARATION FOR USE .....	5
3.1. Initial checks .....	5
3.2. Instrument power supply .....	5
3.3. Storage .....	5
4. NOMENCLATURE .....	6
4.1. Description of the instrument .....	6
4.2. Description of function keys .....	7
4.2.1. HOLD key  .....	7
4.2.2. RANGE key .....	7
4.2.3. MAX MIN key .....	7
4.2.4. Hz% key .....	7
4.2.5. REL key .....	7
4.2.6. MODE key .....	7
4.2.7. LoZ feature .....	8
4.2.8. Disabling the Auto Power Off function .....	8
5. OPERATING INSTRUCTIONS .....	9
5.1. DC Voltage measurement .....	9
5.2. AC Voltage measurement .....	10
5.3. AC/DC Voltage measurement with low impedance (LoZ) .....	11
5.4. Frequency and Duty Cycle measurement .....	12
5.5. Resistance measurement and Continuity test .....	13
5.6. Diode test .....	14
5.7. Capacitance measurement (HT62) .....	15
5.8. Temperature measurement with K probe (HT62) .....	16
5.9. DC Current measurement .....	17
5.10. AC Current measurement .....	18
6. MAINTENANCE .....	19
6.1. Replacing the batteries and the internal fuses .....	19
6.2. Cleaning the instrument .....	19
6.3. End of life .....	19
7. TECHNICAL SPECIFICATIONS .....	20
7.1. Technical characteristics .....	20
7.1.1. Reference standards .....	22
7.1.2. General characteristics .....	22
7.2. Environment .....	22
7.2.1. Environmental conditions for use .....	22
7.3. Accessories .....	22
7.3.1. Accessories provided .....	22
7.3.2. Optional accessories .....	22
8. ASSISTANCE .....	23
8.1. Warranty conditions .....	23
8.2. Assistance .....	23

## 1. PRECAUTIONS AND SAFETY MEASURES

In this manual, the word “instrument” generically indicates models **HT61** and **HT62** if not specified otherwise. The instrument has been designed in compliance with standard IEC/EN61010-1 relevant to electronic measuring instruments. For your safety and in order to prevent damaging the instrument, please carefully follow the procedures described in this manual and read all notes preceded by symbol  with the utmost attention.

Before and after carrying out measurements, carefully observe the following instructions:

- Do not carry out any measurement in humid environments.
- Do not carry out any measurements in case gas, explosive materials or flammables are present, or in dusty environments.
- Avoid any contact with the circuit being measured if no measurements are being carried out.
- Avoid any contact with exposed metal parts, with unused measuring probes or circuits
- Do not carry out any measurement in case you find anomalies in the instrument such as deformation, breaks, substance leaks, absence of display on the screen, etc.
- Pay special attention when measuring voltages higher than 20V, since a risk of electrical shock exists.

In this manual, and on the instrument, the following symbols are used:



Warning: observe the instructions given in this manual; improper use could damage the instrument or its components.



Double-insulated meter



AC voltage



DC voltage or current



Connection to earth

### 1.1. PRELIMINARY INSTRUCTIONS

- This instrument has been designed for use in environments of pollution degree 2.
- It can be used for **VOLTAGE** and **CURRENT** measurements on installations with CAT IV 600V and CAT III 1000V.
- We recommend following the normal safety rules devised by the procedures for carrying out operations on live systems and using the prescribed PPE to protect the user against dangerous currents and the instrument against incorrect use.
- In case the lack of indication of the presence of voltage may represent a danger for the operator, always carry out a continuity measurement before carrying out the measurement on the live system, in order to confirm the correct connection and condition of the leads.
- Only the leads supplied with the instrument guarantee compliance with the safety standards. They must be in good conditions and be replaced with identical models, when necessary.
- Do not test circuits exceeding the specified voltage limits.
- Do not perform any test under environmental conditions exceeding the limits indicated in § 6.2.1.
- Check that the battery is correctly inserted.
- Make sure that the LCD display and the rotary switch indicate the same function.

## 1.2. DURING USE

Please carefully read the following recommendations and instructions:



### CAUTION

Failure to comply with the caution notes and/or instructions may damage the instrument and/or its components or be a source of danger for the operator.

- Before activating the rotary switch, disconnect the test leads from the circuit being measured.
- When the instrument is connected to the circuit being measured, do not touch any unused terminal.
- Do not measure resistance in case external voltages are present; even if the instrument is protected, an excessive voltage may cause malfunction.
- While measuring, if the value or the sign of the quantity being measured remain unchanged, check if the HOLD function is enabled.

## 1.3. AFTER USE

- When measurement is complete, set the rotary switch to OFF to switch off the instrument.
- If the instrument is not to be used for a long time, remove the batteries.

## 1.4. DEFINITION OF MEASUREMENT (OVERVOLTAGE) CATEGORY

Standard "IEC/EN61010-1: Safety requirements for electrical equipment for measurement, control and laboratory use, Part 1: General requirements", defines what measurement category, commonly called overvoltage category, is. § 6.7.4: Measured circuits, reads:

(OMISSIS)

Circuits are divided into the following measurement categories:

- **Measurement Category IV** is for measurements performed at the source of the low-voltage installation.  
*Examples are electricity meters and measurements on primary overcurrent protection devices and ripple control units.*
- **Measurement Category III** is for measurements performed on installations inside buildings.  
*Examples are measurements on distribution boards, circuit breakers, wiring, including cables, bus-bars, junction boxes, switches, socket-outlets in the fixed installation, and equipment for industrial use and some other equipment, for example, stationary motors with permanent connection to fixed installation.*
- **Measurement Category II** is for measurements performed on circuits directly connected to the low-voltage installation.  
*Examples are measurements on household appliances, portable tools and similar equipment.*
- **Measurement Category I** is for measurements performed on circuits not directly connected to MAINS.  
*Examples are measurements on circuits not derived from MAINS, and specially protected (internal) MAINS-derived circuits. In the latter case, transient stresses are variable; for that reason, the standard requires that the transient withstand capability of the equipment is made known to the user.*

## 2. GENERAL DESCRIPTION

The instrument carries out the following measurements:

- DC Voltage
- AC TRMS voltage
- DC/AC voltage with low impedance (LoZ)
- DC Current
- AC TRMS Current
- Resistance and Continuity test
- Diode test
- Capacitance (HT62)
- Current and voltage frequency
- Duty Cycle
- Temperature with K probe (HT62)

Each of these functions can be selected by means of the appropriate switch. The instrument is also equipped with function keys (see § 4.2), an analogue bargraph and backlight. The instrument is also equipped with an Auto Power OFF function (which can be disabled), which automatically switches off the instrument 15 minutes after the last time a function key was pressed or the rotary switch was turned. To switch on the instrument again, turn the rotary switch.

### 2.1. MEASURING AVERAGE VALUES AND TRMS VALUES

Measuring instruments of alternating quantities are divided into two big families:

- AVERAGE-VALUE meters: instruments measuring the value of the sole wave at fundamental frequency (50 or 60 Hz).
- TRMS (True Root Mean Square) VALUE meters: instruments measuring the TRMS value of the quantity being tested.

With a perfectly sinusoidal wave, the two families of instruments provide identical results. With distorted waves, instead, the readings shall differ. Average-value meters provide the RMS value of the sole fundamental wave; TRMS meters, instead, provide the RMS value of the whole wave, including harmonics (within the instruments bandwidth). Therefore, by measuring the same quantity with instruments from both families, the values obtained are identical only if the wave is perfectly sinusoidal. In case it is distorted, TRMS meters shall provide higher values than the values read by average-value meters.

### 2.2. DEFINITION OF TRUE ROOT MEAN SQUARE VALUE AND CREST FACTOR

The root mean square value of current is defined as follows: *"In a time equal to a period, an alternating current with a root mean square value of 1A intensity, circulating on a resistor, dissipates the same energy that, during the same time, would be dissipated by a direct current with an intensity of 1A"*. This definition results in the numeric expression:

$$G = \sqrt{\frac{1}{T} \int_{t_0}^{t_0+T} g^2(t) dt}$$

The root mean square value is indicated with the acronym RMS.

The Crest Factor is defined as the relationship between the Peak Value of a signal and its

RMS value:  $CF (G) = \frac{G_p}{G_{RMS}}$  This value changes with the signal waveform, for a purely

sinusoidal wave it is  $\sqrt{2} = 1.41$ . In case of distortion, the Crest Factor takes higher values as wave distortion increases.

### 3. PREPARATION FOR USE

#### 3.1. INITIAL CHECKS

Before shipping, the instrument has been checked from an electric as well as mechanical point of view. All possible precautions have been taken so that the instrument is delivered undamaged.

However, we recommend generally checking the instrument in order to detect possible damage suffered during transport. In case anomalies are found, immediately contact the forwarding agent.

We also recommend checking that the packaging contains all components indicated in § 6.3.1. In case of discrepancy, please contact the Dealer.

In case the instrument should be returned, please follow the instructions given in § 7.

#### 3.2. INSTRUMENT POWER SUPPLY

The instrument is supplied with 1x9V alkaline battery type IEC 6F22, included in the package. When the battery is flat, the symbol  appears on the display. To replace/insert the battery, see § 6.1.

#### 3.3. STORAGE

In order to guarantee precise measurement, after a long storage time under extreme environmental conditions, wait for the instrument to come back to normal condition (see § 6.2.1).

## 4. NOMENCLATURE

### 4.1. DESCRIPTION OF THE INSTRUMENT

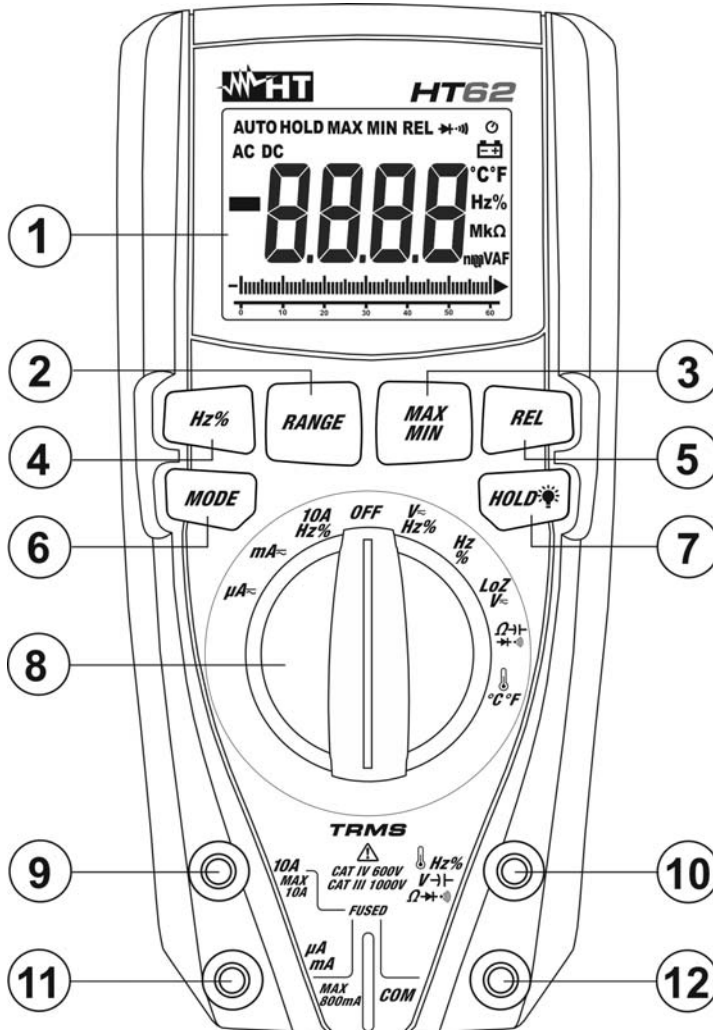



#### CAPTION:

1. LCD display
2. **RANGE** key
3. **MAXMIN** key
4. **Hz%** key
5. **REL** key
6. **MODE** key
7. **HOLD** key
8. Rotary selector switch
9. Input terminal **10A**
10. Input terminal **VHz%Ω** (HT61) or **Hz%V-Ω** (HT62).
11. Input terminal **mAμA**
12. Input terminal **COM**



Fig. 1: Description of the instrument

## 4.2. DESCRIPTION OF FUNCTION KEYS



### 4.2.1. HOLD key

Pressing the **HOLD**  key freezes the value of the measured quantity on the display. After pressing this key, the message "HOLD" appears on the display. Press the **HOLD** key again to exit the function. Press and hold the **HOLD**  key for a long time in order to activate/deactivate the display's backlight. This function is activated in any position of the rotary switch and is automatically deactivated after approx. 10s.

### 4.2.2. RANGE key

Press the **RANGE** key to activate the manual mode and to disable the Autorange function. The symbol "AUTO" disappears from the upper left part of the display. In manual mode, press the **RANGE** key to change measuring range: the relevant decimal point will change its position. The **RANGE** key is not active in Frequency measurement and Duty cycle test and in positions  and  (HT62) of the rotary switch. In Autorange mode, the instrument selects the most appropriate ratio for carrying out measurement. If a reading is higher than the maximum measurable value, the indication "O.L" appears on the display. Press and hold the **RANGE** key for more than 1 second to exit the manual mode.

### 4.2.3. MAX MIN key

Pressing the **MAX MIN** key once activates the detection of maximum and minimum values of the quantity being tested. Both values are constantly updated and are displayed cyclically every time the same key is pressed again. The display shows the symbol associated with the selected function: "MAX" for maximum value and "MIN" for minimum value. The **MAX MIN** key is not active when the HOLD function is activated. Pressing the **MAX MIN** key the "AUTO" and bargraph disappears. The **MAX MIN** key is not active in Frequency measurement and Duty cycle test and in positions  and  (HT62) of the rotary switch. Press and hold the **MAX MIN** key for more than 1 second or turn the selector to exit the function.



### 4.2.4. Hz% key

Press the **Hz%** key to select frequency measurement and duty cycle test in positions **V $\sim$ Hz%**, **10AHZ%**, **mA $\sim$  (AC)**,  **$\mu$ A $\sim$  (AC)** and **Hz%** of the rotary switch. The frequency range is different in the different positions.

### 4.2.5. REL key

Press the **REL** key to activate relative measurement. The instrument zeroes the display and saves the displayed value as a reference value which subsequent measurements will be referred to. The symbol "REL" appears on the display. This function is not active for the following measurements: Hz, Duty Cycle, Continuity Test, Diode test and Temperature (HT62). Pressing the **REL** key the "AUTO" and bargraph disappears Press the key again to exit the function.

### 4.2.6. MODE key

Pressing the **MODE** key allows selecting a double function on the rotary switch. In particular, it is active in position  and  (HT62) to select diode test, continuity test, capacitance measurement (HT62) and resistance measurement, in position  **°C°F** (HT62) to select temperature measurement in °C or °F, in positions **V $\sim$ Hz%** and **LoZV $\sim$**  for AC or DC voltage selection and **mA $\sim$** ,  **$\mu$ A $\sim$**  to select AC or DC measurements



#### 4.2.7. LoZ feature

This mode permits to perform the AC/DC voltage measurement with a low input impedance in way to avoid the wrong readings due to stray voltage in capacitive coupled.



#### CAUTION

Inserting the instrument between phase and ground conductors, the RCDs protection devices can be tripping out during the test. For phase-PE voltage measurement after a RCD device preliminarily connect the test leads between phase and neutral cables at least for 5s, then perform the phase-PE measurement to avoid unexpected trips-out

#### 4.2.8. Disabling the Auto Power Off function

The instrument switches off automatically approximately 15 minutes after it was last used. The symbol “⏻” appears on the display. To disable the Auto Power Off function, proceed as follows:

- Switch off the instrument (**OFF**)
- Press and hold the **MODE** key, switch on the instrument by turning the rotary switch. The symbol “⏻” disappears from the display
- Switch off and then on again the instrument to enable the function.

## 5. OPERATING INSTRUCTIONS

### 5.1. DC VOLTAGE MEASUREMENT

#### CAUTION



The maximum input DC voltage is 1000V. Do not measure voltages exceeding the limits given in this manual. Exceeding voltage limits could result in electrical shocks to the user and damage to the instrument.

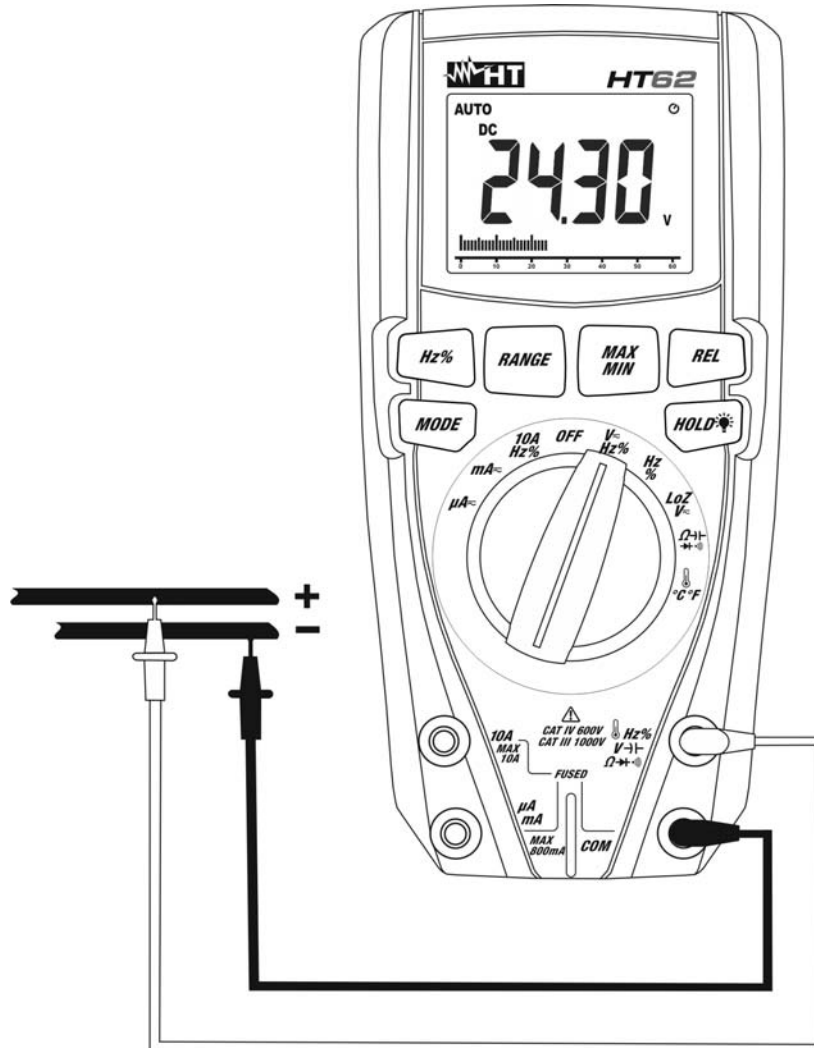

Fig. 2: Use of the instrument for DC voltage measurement

1. Select position  $V \sim \text{Hz}\%$
2. Press the **MODE** key until the symbol "DC" is displayed
3. Insert the red cable into input terminal  $V \sim \text{Hz}\% \Omega \rightarrow \rightarrow \rightarrow$ ) (HT61) or  $\Omega \rightarrow \rightarrow \rightarrow \rightarrow \rightarrow \rightarrow \rightarrow$ ) (HT62) and the black cable into input terminal **COM**.
4. Position the red lead and the black lead respectively in the spots with positive and negative potential of the circuit to be measured (see Fig. 2). The display shows the value of voltage.
5. If the display shows the message "O.L", select a higher range.
6. When symbol "-" appears on the instrument's display, it means that voltage has the opposite direction with respect to the connection in Fig. 2.
7. To use the HOLD, RANGE, MAX MIN and REL functions, see § 4.2.

## 5.2. AC VOLTAGE MEASUREMENT

### CAUTION



The maximum input AC voltage is 1000V. Do not measure voltages exceeding the limits given in this manual. Exceeding voltage limits could result in electrical shocks to the user and damage to the instrument.



Fig. 3: Use of the instrument for AC voltage measurement

1. Select position  $V \sim \text{Hz}\%$
2. Press the **MODE** key until the symbol "AC" is displayed
3. Insert the red cable into input terminal  $V \sim \text{Hz}\% \Omega \rightarrow \rightarrow \rightarrow$ ) (HT61) or  $\Omega \rightarrow \rightarrow \rightarrow V \sim \text{Hz}\% \Omega \rightarrow \rightarrow \rightarrow$ ) (HT62) and the black cable into input terminal **COM**.
4. Position the red lead and the black lead respectively in the spots of the circuit to be measured (see Fig. 3). The display shows the value of voltage.
5. If the display shows the message "O.L", select a higher range.
6. Press the **Hz%** key to select measurements "Hz" or "%" in order to display the values of frequency and duty cycle of input voltage. The bargraph is not active in these functions.
7. To use the HOLD, RANGE, MAX MIN and REL functions, see § 4.2.

### 5.3. AC/DC VOLTAGE MEASUREMENT WITH LOW IMPEDANCE (LOZ)



#### CAUTION

The maximum input AC/DC voltage is 600V. Do not measure voltages exceeding the limits given in this manual. Exceeding voltage limits could result in electrical shocks to the user and damage to the instrument.

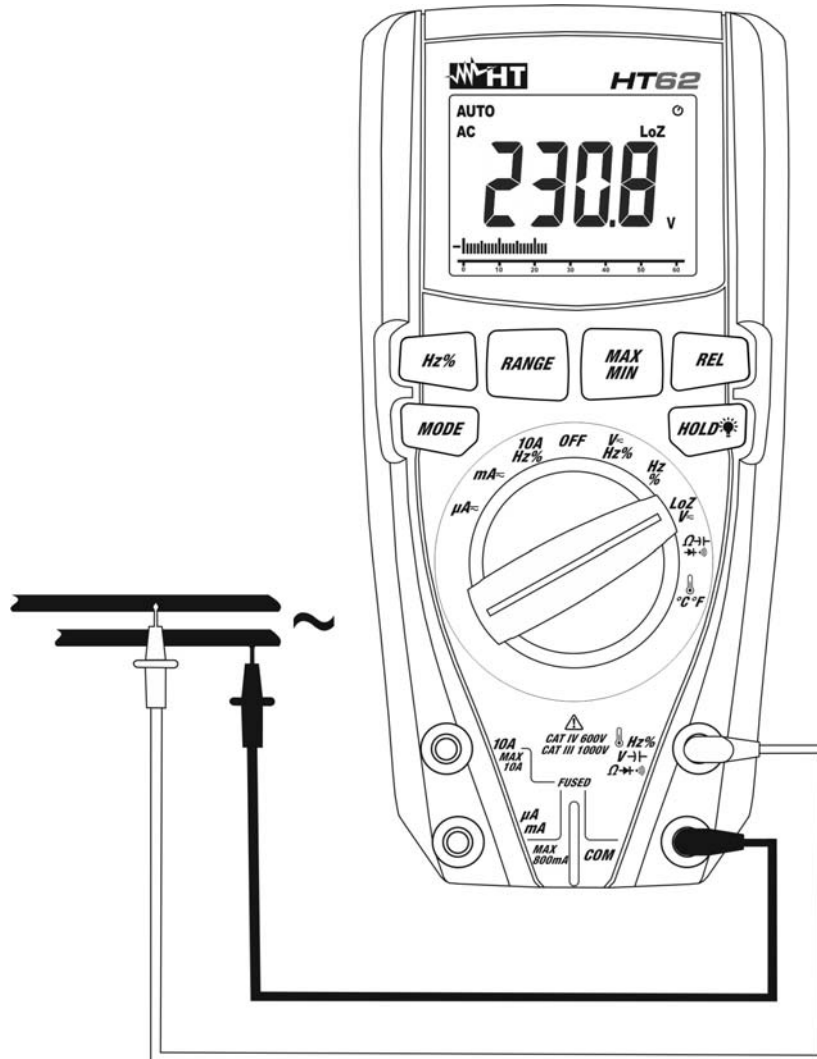

Fig. 4: Use of the instrument for AC/DC voltage measurement with low impedance (LoZ)

1. Select position **LoZV~**
2. Press the **MODE** key until the symbol "DC" is displayed
3. Insert the red cable into input terminal **VHz%Ω▶|•|))** (HT61) or **ΩHz%V~|~Ω▶|•|))** (HT62) and the black cable into input terminal **COM**.
4. Position the red lead and the black lead respectively in the desired spots of the circuit to be measured (see Fig. 4) for AC voltage measurement or in the spots with positive and negative potential of the circuit to be measured (see Fig. 2) for DC voltage measurement. The display shows the value of voltage.
5. If the display shows the message "O.L", select a higher range.
6. When symbol "-" appears on the instrument's display, it means that voltage has the opposite direction with respect to the connection in Fig. 2.
7. To use the HOLD, RANGE, MAX MIN and REL functions, see § 4.2

## 5.4. FREQUENCY AND DUTY CYCLE MEASUREMENT

### CAUTION



The maximum input AC voltage is 1000V. Do not measure voltages exceeding the limits given in this manual. Exceeding voltage limits could result in electrical shocks to the user and damage to the instrument.

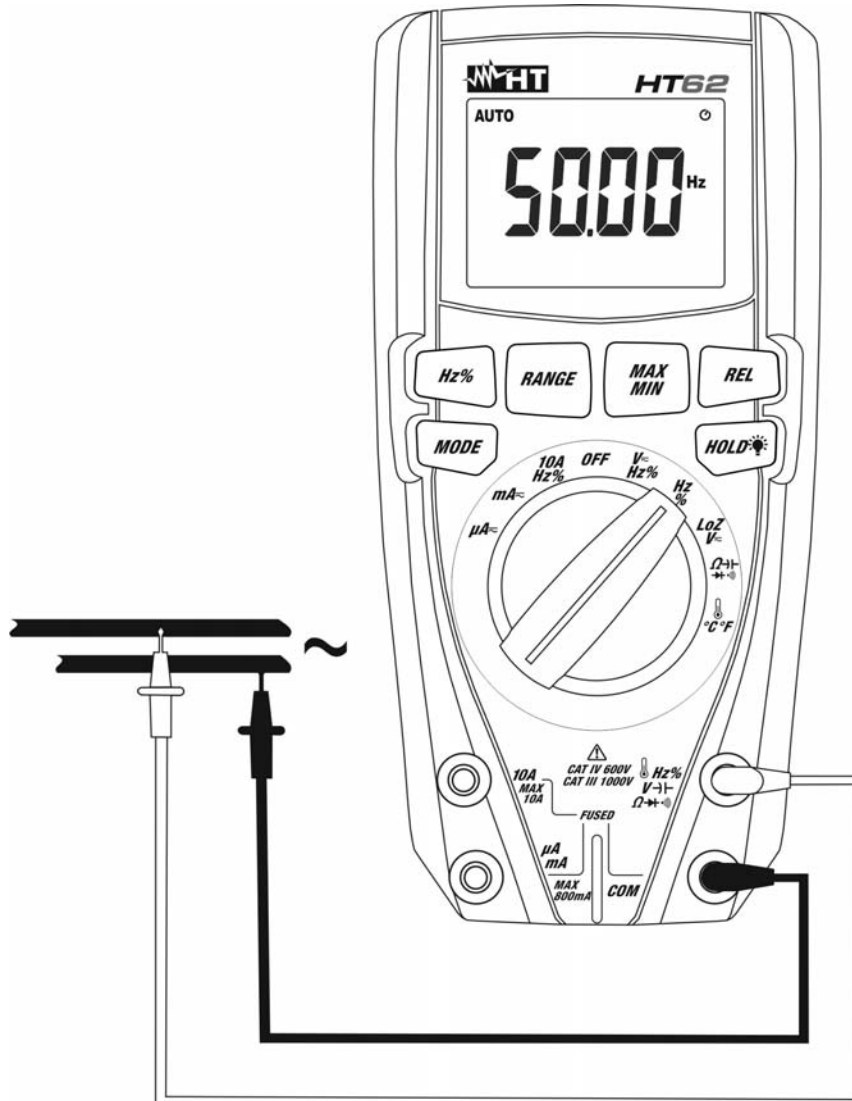

Fig. 5: Use of the instrument for frequency measurement and duty cycle test.

1. Select position **Hz%**.
2. Press the **Hz%** key to select measurements "Hz" or "%" in order to display the values of frequency and duty cycle of input voltage.
3. Insert the red cable into input terminal **VHz%** (HT61) or **VHz%** (HT62) and the black cable into input terminal **COM**.
4. Position the red lead and the black lead respectively in the spots of the circuit to be measured (see Fig. 5). The value of frequency (Hz) or of duty cycle (%) is shown on the display. The bargraph is not active in these functions.
5. If the display shows the message "O.L", select a higher range.
6. To use the HOLD function, see § 4.2.

## 5.5. RESISTANCE MEASUREMENT AND CONTINUITY TEST

### CAUTION



Before attempting any resistance measurement, cut off power supply from the circuit to be measured and make sure that all capacitors are discharged, if present.

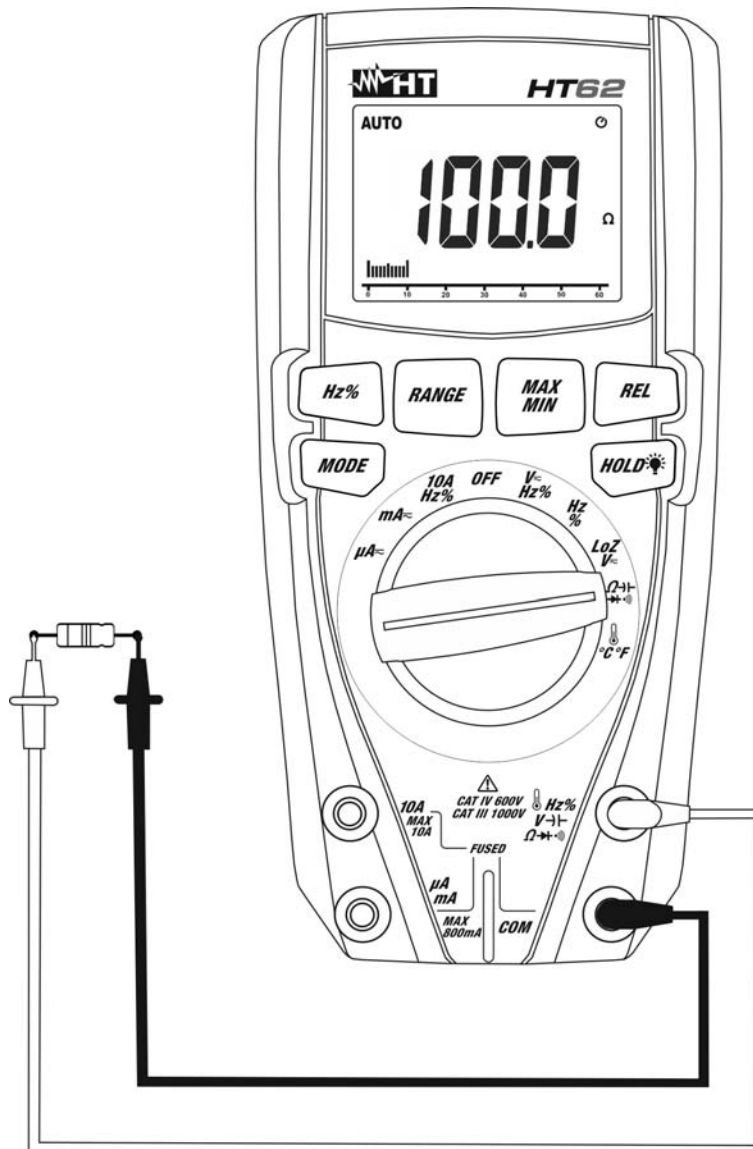

Fig. 6: Use of the instrument for resistance measurement and continuity test

1. Select position  $\Omega \rightarrow \rightarrow \rightarrow$  (HT61) or  $\Omega \rightarrow \rightarrow \rightarrow$  (HT62).
2. Insert the red cable into input terminal  $VHz\%\Omega \rightarrow \rightarrow \rightarrow$  (HT61) or  $\Omega \rightarrow \rightarrow \rightarrow$  (HT62) and the black cable into input terminal **COM**.
3. Position the test leads in the desired spots of the circuit to be measured (see Fig. 6). The display shows the value of resistance.
4. If the display shows the message "O.L", select a higher range.
5. Press the **MODE** key to select  $\rightarrow \rightarrow \rightarrow$  measurement, relevant to the continuity test, and position the test leads in the desired spots of the circuit to be measured.
6. The value of resistance (which is only indicative) is displayed in  $\Omega$  and the instrument sounds if the value of resistance is  $<100\Omega$
7. To use the HOLD, RANGE, MAX MIN and REL functions, see § 4.2.

## 5.6. DIODE TEST

### CAUTION



Before attempting any resistance measurement, cut off power supply from the circuit to be measured and make sure that all capacitors are discharged, if present.

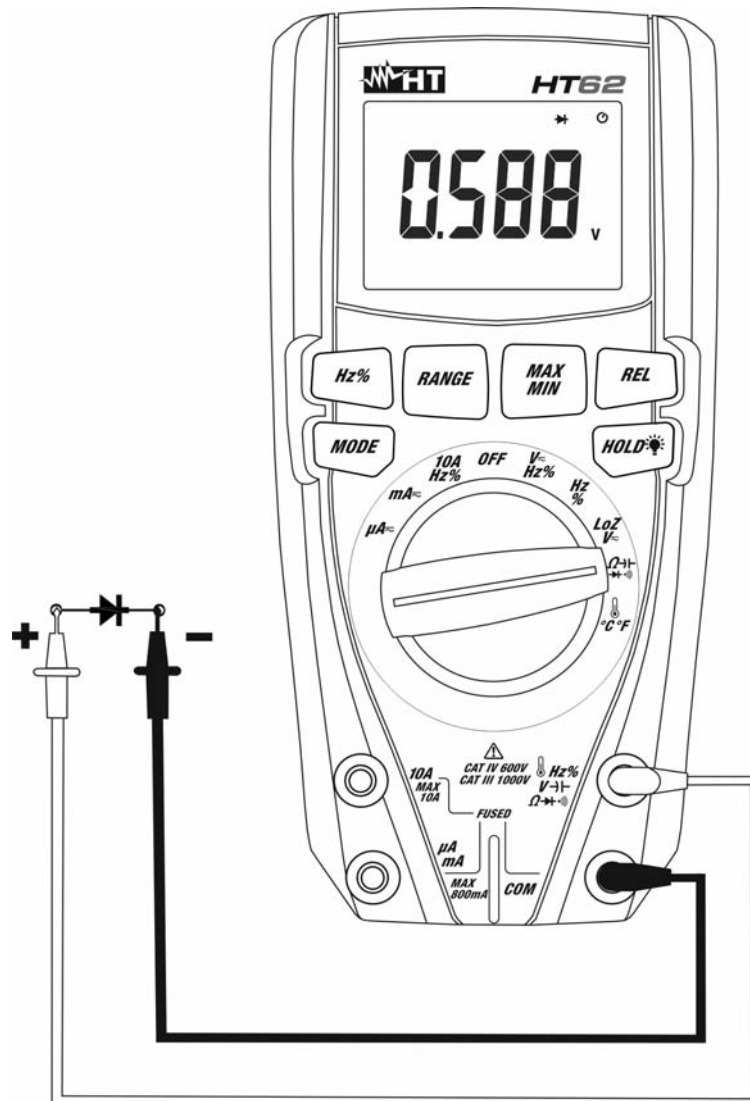

Fig. 7: Use of the instrument for diode test

1. Select position  $\Omega \rightarrow \text{diode symbol}$  (HT61) or  $\Omega \rightarrow \text{diode symbol}$  (HT62).
2. Press the **MODE** key to select " $\rightarrow$ " measurement.
3. Insert the red cable into input terminal **VHz% $\Omega \rightarrow \text{diode symbol}$**  (HT61) or  **$\text{Hz%V} \rightarrow \text{diode symbol}$**  (HT62) and the black cable into input terminal **COM**.
4. Position the leads at the ends of the diode to be tested (see Fig. 7), respecting the indicated polarity. The value of directly polarized threshold voltage is shown on the display.
5. If threshold value is equal to 0mV, the P-N junction of the diode is short-circuited.
6. If the display shows the message "**O.L**", the terminals of the diode are reversed with respect to the indication given in Fig. 7 or the P-N junction of the diode is damaged.



## 5.7. CAPACITANCE MEASUREMENT (HT62)

### CAUTION



Before carrying out capacitance measurements on circuits or capacitors, cut off power supply from the circuit being tested and let all capacitance in it be discharged. When connecting the multimeter and the capacitance to be measured, respect the correct polarity (when required).

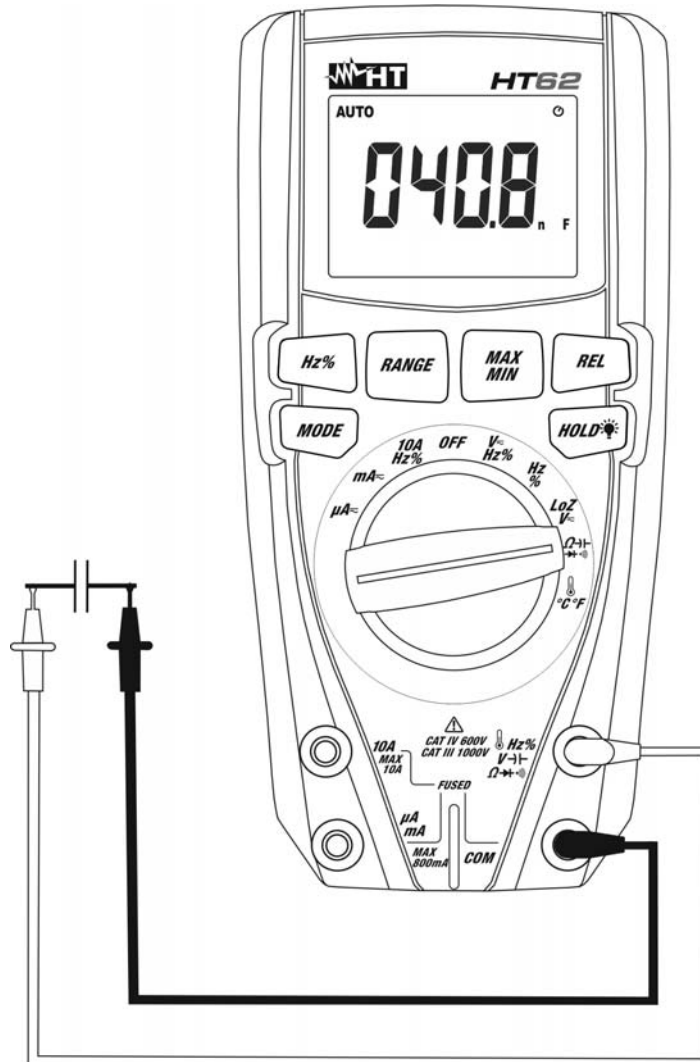

Fig. 8: Use of the instrument for Capacitance measurement

1. Select position  $\Omega \rightarrow \text{||} \rightarrow \text{||}$
2. Press the **MODE** key until the symbol “nF” is displayed.
3. Insert the red cable into input terminal  $\text{LoZ}$  and the black cable into input terminal **COM**.
4. Press the **REL** button before carrying out measurements.
5. Position the leads at the ends of the capacitor to be tested, respecting, if necessary, the positive (red cable) and negative (black cable) polarity (see Fig. 8). The display shows the value of capacitance.
6. The message “O.L.” indicates that the value of capacitance exceeds the maximum measurable value.
7. To use the HOLD function, see § 4.2.



## 5.8. TEMPERATURE MEASUREMENT WITH K PROBE (HT62)



### CAUTION

Before attempting any temperature measurement, cut off power supply from the circuit to be measured and make sure that all capacitors are discharged, if present.



Fig. 9: Use of the instrument for Temperature measurement

1. Select position  $\text{°C}^{\text{°F}}$
2. Press the **MODE** key until the symbol “°C” or “°F” is displayed.
3. Insert the provided adapter into input terminals  $\text{Hz}\% \text{V} \rightarrow \Omega \rightarrow +)$  (polarity +) and **COM** (polarity -) (see Fig. 9)
4. Connect the provided K-type wire probe or the optional K-type thermocouple (see § ) to the instrument by means of the adapter, respecting the positive and negative polarity on it. The display shows the value of temperature.
5. The message “**O.L.**” indicates that the value of temperature exceeds the maximum measurable value.
6. To use the HOLD function, see § 4.2.

## 5.9. DC CURRENT MEASUREMENT

### CAUTION



Maximum input DC current is 10A (input **10A**) or 600mA (input **mA $\mu$ A**). Do not measure currents exceeding the limits given in this manual. Exceeding voltage limits could result in electrical shocks to the user and damage to the instrument.

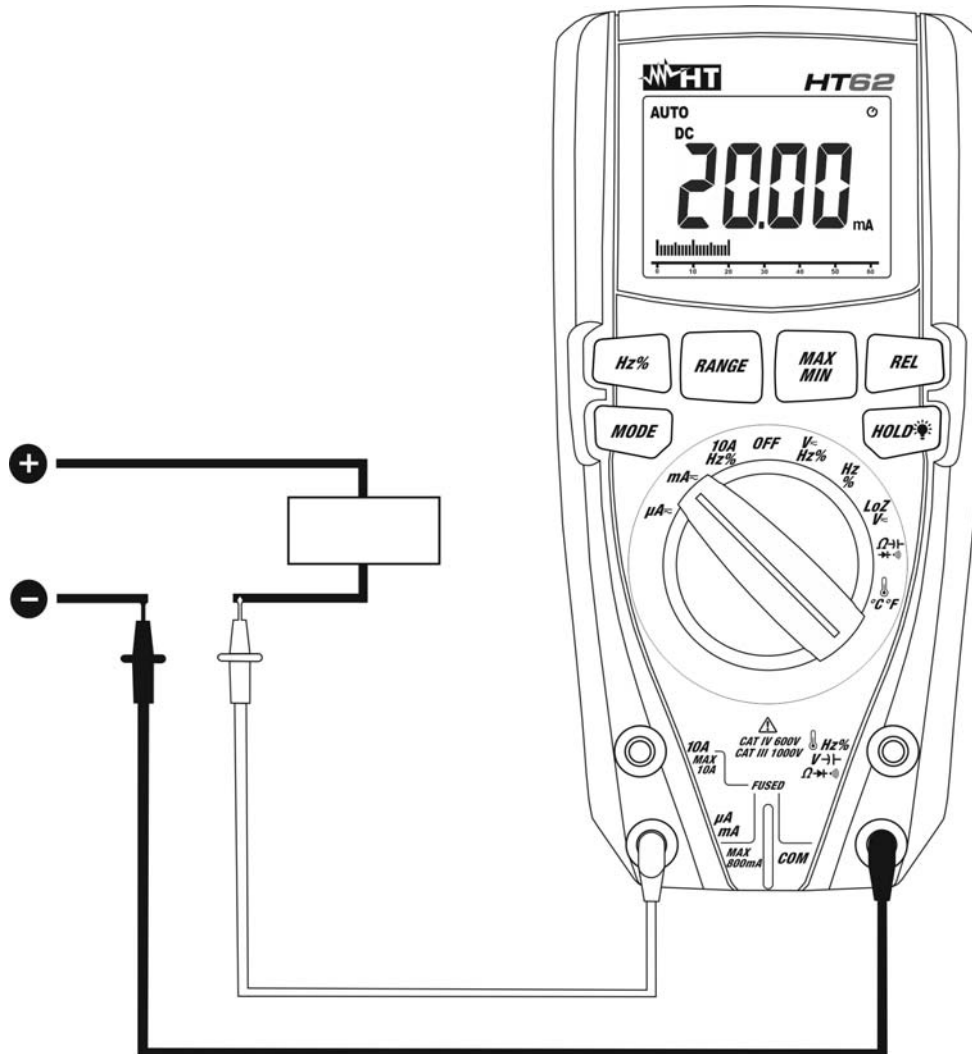

Fig. 10: Use of the instrument for DC current measurement

1. Cut off power supply from the circuit to be measured.
2. Select position  $\mu\text{A}$ ,  $\text{mA}$  or  $10\text{A}$ .
3. Insert the red cable into input terminal **10A** or into input terminal **mA $\mu$ A** and the black cable into input terminal **COM**.
4. Connect the red lead and the black lead in series to the circuit whose current you want to measure, respecting polarity and current direction (see Fig. 10).
5. Supply the circuit to be measured. The display shows the value of current.
6. If the display shows the message "**O.L.**", the maximum measurable value has been reached.
7. When symbol "-" appears on the instrument's display, it means that current has the opposite direction with respect to the connection in Fig. 10.
8. To use the HOLD, RANGE, MAX MIN and REL functions, see § 4.2.

## 5.10. AC CURRENT MEASUREMENT

### CAUTION



Maximum input AC current is 10A (input **10A**) or 600mA (input **mA $\mu$ A**). Do not measure currents exceeding the limits given in this manual. Exceeding voltage limits could result in electrical shocks to the user and damage to the instrument.

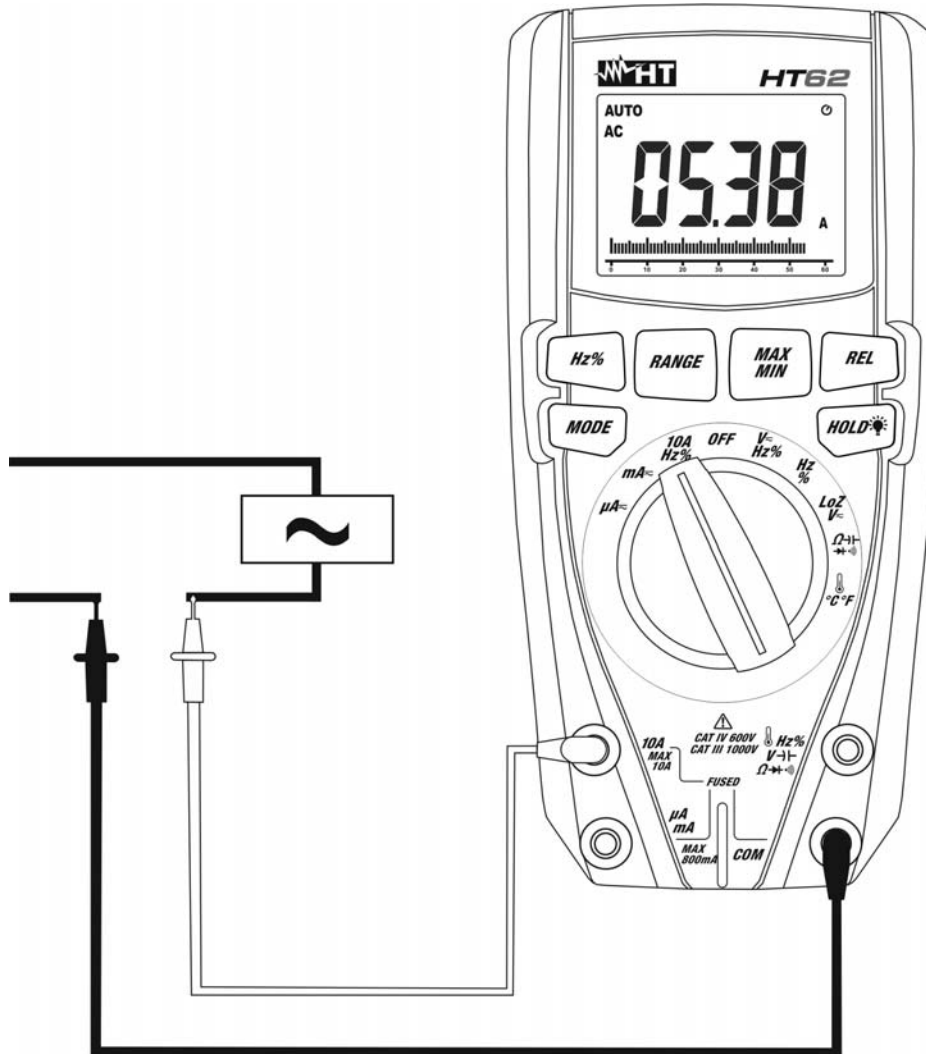

Fig. 11: Use of the instrument for AC current measurement

1. Cut off power supply from the circuit to be measured.
2. Select position  $\mu\text{A}$ ,  $\text{mA}$  or  $10\text{A Hz\%}$ .
3. Press the **MODE** key to select "AC" measurement.
4. Insert the red cable into input terminal **10A** or into input terminal **mA $\mu$ A** and the black cable into input terminal **COM**.
5. Connect the red lead and the black lead in series to the circuit whose current you want to measure, respecting polarity and current direction (see Fig. 11).
6. Supply the circuit to be measured. The display shows the value of current.
7. If the display shows the message "O.L.", the maximum measurable value has been reached.
8. Press the **Hz%** key to select measurements "Hz" or "%" in order to display the values of frequency and duty cycle of input current. The bargraph is not active in these functions.
9. To use the HOLD, RANGE, MAX MIN and REL functions, see § 4.2.

## 6. MAINTENANCE

### CAUTION







- Only expert and trained technicians should perform maintenance operations. Before carrying out maintenance operations, disconnect all cables from the input terminals.
- Do not use the instrument in environments with high humidity levels or high temperatures. Do not expose to direct sunlight.
- Always switch off the instrument after use. In case the instrument is not to be used for a long time, remove the battery to avoid liquid leaks that could damage the instrument's internal circuits.





### 6.1. REPLACING THE BATTERIES AND THE INTERNAL FUSES

When the LCD display shows the symbol “”, it is necessary to replace the battery.

#### Replacing the battery

1. Position the rotary switch to **OFF** and remove the cables from the input terminals.
2. Turn the fastening screw of the battery compartment cover from position “” to position “” and remove it.
3. Remove the battery and insert a new battery of the same type (see § ), respecting the indicated polarity.
4. Restore the battery compartment cover into place and turn the fastening screw from position “” to position “”.
5. Do not scatter old batteries into the environment. Use the relevant containers for disposal.

#### Replacement of fuses

1. Position the rotary switch to **OFF** and remove the cables from the input terminals.
2. Turn the fastening screw of the battery compartment cover from position “” to position “” and remove it.
3. Remove the damaged fuse and insert a new one of the same type (see § ), respecting the indicated polarity.
4. Restore the battery compartment cover into place and turn the fastening screw from position “” to position “”.

### 6.2. CLEANING THE INSTRUMENT

Use a soft and dry cloth to clean the instrument. Never use wet cloths, solvents, water, etc.

### 6.3. END OF LIFE



**WARNING:** the symbol on the instrument indicates that the appliance and its accessories must be collected separately and correctly disposed of.

## 7. TECHNICAL SPECIFICATIONS

### 7.1. TECHNICAL CHARACTERISTICS

Accuracy calculated as [%reading + (num. digits\*resolution)] at 18°C ÷ 28°C <75%HR

#### DC Voltage

Range	Resolution	Accuracy	Input impedance	Protection against overcharge
600.0mV	0.1mV	$\pm(0.8\%rdg + 5dgt)$	>10M $\Omega$	1000VDC/ACrms
6,000V	0,001V			
60.00V	0.01V			
600.0V	0.1V			
1000V	1V			

#### AC TRMS Voltage

Range	Resolution	Accuracy (*)		Protection against overcharge
		(50Hz÷60Hz)	(61Hz÷400Hz)	
6.000V	0.001V	$\pm(1.0\%rdg + 8dgt)$	$\pm(2.0\%rdg + 8dgt)$	1000VDC/ACrms
60.00V	0.01V			
600.0V	0.1V			
1000V	1V	$\pm(1.2\%rdg + 8dgt)$	$\pm(2.5\%rdg + 8dgt)$	

(\*) Accuracy specified from 5% to 100% of the measuring range, Input impedance: > 10M $\Omega$

Crest factor:  $\leq 3$  (up to 500V),  $\leq 1.5$  (up to 1000V)

#### DC/AC TRMS voltage with low impedance (LoZ)

Range	Resolution	Accuracy (50 ÷ 400Hz)	Input impedance	Protection against overcharge
600.0mV(*)	0.1mV	$\pm(3.0\%rdg + 40dgt)$	approx. 3k $\Omega$	600VDC/ACrms
6.000V	0.001V			
60.00V	0.01V			
600.0V	0.1V			
600V	1V			

(\*) DC only

#### DC Current

Range	Resolution	Accuracy	Protection against overcharge
600.0 $\mu$ A	0.1 $\mu$ A	$\pm(1.0\%rdg + 3dgt)$	Quick fuse 800mA/1000V
6000 $\mu$ A	1 $\mu$ A		
60.00mA	0.01mA		
600.0mA	0.1mA		
6.000A	0.001A	$\pm(1.5\%rdg + 3dgt)$	Quick fuse 10A/1000V
10.00A (*)	0.01A		

(\*) 20A for max 30s with not declared accuracy

#### AC TRMS Current

Range	Resolution	Accuracy (*) (40Hz÷400Hz)	Protection against overcharge
600.0 $\mu$ A	0.1 $\mu$ A	$\pm(1.5\%rdg + 8dgt)$	Quick fuse 800mA/1000V
6000 $\mu$ A	1 $\mu$ A		
60.00mA	0.01mA		
600.0mA	0.1mA		
6.000A	0.001A	$\pm(2.0\%rdg + 8dgt)$	Quick fuse 10A/1000V
10.00A (**)	0.01A		

(\*) Accuracy specified from 5% to 100% of the measuring range, (\*\*) 20A for max 30s with not declared accuracy

**Diode test**

Function	Test current	Max voltage with open circuit
	<0.9mA	2.8VDC

**Resistance and Continuity test**

Range	Resolution	Accuracy	Buzzer	Protection against overcharge
600.0Ω	0.1Ω	±(1.0%rdg + 4dgt)	<100Ω	1000VDC/ACrms
6.000kΩ	0.001kΩ			
60.00kΩ	0.01kΩ			
600.0kΩ	0.1kΩ			
6.000MΩ	0.001MΩ	±(2.0%rdg + 10dgt)		
60.00MΩ	0.01MΩ			

**Frequency (electronic circuits)**

Range	Resolution	Accuracy	Protection against overcharge
10Hz ÷ 400Hz	0.001Hz	±(1.5%rdg + 5dgt)	1000VDC/ACrms

Sensitivity: 15Vrms (voltage), 10Arms (current)

**Frequency (electronic circuits)**

Range	Resolution	Accuracy	Protection against overcharge
9.999Hz	0.001Hz	±(0.1%rdg + 8dgt)	1000VDC/ACrms
99.99Hz	0.01Hz		
999.9Hz	0.1Hz		
9.999kHz	0.001kHz		
99.99kHz	0.01kHz		
999.9kHz	0.1kHz		
9.999MHz	0.001MHz		
40.00MHz	0.01MHz		

Sensitivity: &gt;0.8Vrms (@ 20% ÷ 80% duty cycle) and f&lt;100kHz; &gt;5Vrms (@ 20% ÷ 80% duty cycle) and f&gt;100kHz

**Duty Cycle**

Range	Resolution	Accuracy
0.1% ÷ 99.9%	0.1%	±(1.2%rdg + 2dgt)

Pulse frequency range: 5Hz ÷ 150kHz, Pulse amplitude: 100μs ÷ 100ms

**Capacitance (HT62)**

Range	Resolution	Accuracy	Protection against overcharge
40.00nF	0.01nF	±(3.5%rdg + 50dgt)	1000VDC/ACrms
400.0nF	0.1nF	±(3.5%rdg + 4dgt)	
4,000μF	0,001μF		
40.00μF	0.01μF		
400.0μF	0.1μF		
1000μF	1μF	±(5.0%rdg + 5dgt)	

**Temperature with K probe (HT62)**

Range	Resolution	Accuracy (*)	Protection against overcharge
-45.0°C ÷ 400.0°C	0.1°C	±(3.5%rdg + 5°C)	1000VDC/ACrms
401°C ÷ 750°C	1°C		
-50.0°F ÷ 752.0°F	0.1°F	±(3.5%rdg + 9°F)	
752°F ÷ 1382°F	1°F		

(\*) Instrument accuracy with no probe

### 7.1.1. Reference standards

Safety:	IEC/EN61010-1
EMC:	IEC/EN 61326-1
Insulation:	double insulation
Pollution level:	2
Overvoltage category:	CAT IV 600V, CAT III 1000V
Max operating altitude:	2000m (6562ft)

### 7.1.2. General characteristics

#### Mechanical characteristics

Size (L x W x H):	175 x 85 x 55mm (7 x 3 x 2in)
Weight (batteries included):	360g (13 ounces)
Mechanical protection:	IP40

#### Power supply

Battery type:	1x9V battery type NEDA 1604 IEC 6F22
Low battery indication:	symbol "⎓" on the display
Battery life:	ca.25h (backlight ON), ca 50h (backlight OFF)
Auto Power Off:	after 15 minutes' idling (can be disabled)
Fuses:	F10A/1000V, 10 x 38mm (input <b>10A</b> ) F800mA/1000V, 6 x 32mm (input <b>mA<math>\mu</math>A</b> )

#### Display

Conversion:	TRMS
Characteristics:	4-digit LCD with maximum reading 6000 dots plus decimal sign and point, backlight and bargraph.
Sampling frequency:	2 times/s

## 7.2. ENVIRONMENT

### 7.2.1. Environmental conditions for use

Reference temperature:	18°C ÷ 28°C (64°F ÷ 82°F)
Operating temperature:	5°C ÷ 40°C (41°F ÷ 104°F)
Allowable relative humidity:	<80%HR
Storage temperature:	-20° ÷ 60°C (-4°F ÷ 140°F)
Storage humidity:	<80%HR

**This instrument satisfies the requirements of Low Voltage Directive 2014/35/EU (LVD) and of EMC Directive 2014/30/EU**

**This instrument satisfies the requirements of European Directive 2011/65/EU (RoHS) and 2012/19/EU (WEEE)**

## 7.3. ACCESSORIES

### 7.3.1. Accessories provided

- Pair of test leads with 2/4mm tips
- Adapter + K-type wire probe (HT62)
- Battery
- Carrying bag
- User manual

### 7.3.2. Optional accessories

- |  |            |
|--|------------|
| • K-type probe for air and gas temperature (HT62)          | Code TK107 |
| • K-type probe for semisolid substance temperature (HT62)  | Code TK108 |
| • K-type probe for liquid substance temperature (HT62)     | Code TK109 |
| • K-type probe for surface temperature (HT62)              | Code TK110 |
| • K-type probe for surface temperature with 90° tip (HT62) | Code TK111 |



## 8. ASSISTANCE

### 8.1. WARRANTY CONDITIONS

This instrument is warranted against any material or manufacturing defect, in compliance with the general sales conditions. During the warranty period, defective parts may be replaced. However, the manufacturer reserves the right to repair or replace the product. Should the instrument be returned to the After-sales Service or to a Dealer, transport will be at the Customer's charge. However, shipment will be agreed in advance. A report will always be enclosed to a shipment, stating the reasons for the product's return. Only use original packaging for shipment. Any damage due to the use of non-original packaging material will be charged to the Customer. The manufacturer declines any responsibility for injury to people or damage to property.

The warranty shall not apply in the following cases:

- Repair and/or replacement of accessories and battery (not covered by warranty).
- Repairs that may become necessary as a consequence of an incorrect use of the instrument or due to its use together with non-compatible appliances.
- Repairs that may become necessary as a consequence of improper packaging.
- Repairs which may become necessary as a consequence of interventions performed by unauthorized personnel.
- Modifications to the instrument performed without the manufacturer's explicit authorization.
- Use not provided for in the instrument's specifications or in the instruction manual.

The content of this manual cannot be reproduced in any form without the manufacturer's authorization.

**Our products are patented and our trademarks are registered. The manufacturer reserves the right to make changes in the specifications and prices if this is due to improvements in technology.**

### 8.2. ASSISTANCE

If the instrument does not operate properly, before contacting the After-sales Service, please check the conditions of battery and cables and replace them, if necessary. Should the instrument still operate improperly, check that the product is operated according to the instructions given in this manual. Should the instrument be returned to the After-sales Service or to a Dealer, transport will be at the Customer's charge. However, shipment will be agreed in advance. A report will always be enclosed to a shipment, stating the reasons for the product's return. Only use original packaging for shipment; any damage due to the use of non-original packaging material will be charged to the Customer.