

ENGLISH

User manual



Table of Content:

1 PRECAUTIONS AND SAFETY MEASURES	2
1.1 Preliminary instructions	2
1.2 During use	3
1.3 After use	3
1.4 Definition of measurement (overvoltage) category	3
2 GENERAL DESCRIPTION	4
2.1 Instrument features	4
3 PREPARATION FOR USE	5
3.1 Initial inspections	5
3.2 Instrument power supply	5
3.3 Calibration	5
3.4 Storage	5
4 DESCRIPTION OF PARTS	6
4.1 Instrument description	6
4.2 Description of test leads	7
5 INITIAL OPERATIONS	8
5.1 Switching on the instrument	8
5.1.1 Mains powered instrument operation	8
5.1.2 Backlight operation	8
5.1.3 Autocalibration.....	8
5.2 Configuration and Setup of systems parameters	9
6 HOW TO PERFORM THE MEASUREMENTS	10
6.1 Theory of insulation resistance measurement	10
6.1.1 Time dependence test – Diagnostic test	12
6.1.2 Withstanding voltage test	15
6.2 Guard terminal.....	16
6.3 Use of internal filters.....	17
6.3.1 The purpose of filtering.....	17
6.4 Voltage measurement	18
6.5 Insulation resistance measurement	19
6.5.1 Setting of parameters	19
6.5.2 Perform the measurement.....	20
6.6 Diagnostic test	22
6.6.1 Setting of parameters	22
6.6.2 Perform the measurement.....	23
6.7 Insulation resistance with step voltage test.....	25
6.7.1 Setting of parameters	25
6.7.2 Perform the measurement.....	26
6.8 Withstanding voltage test	28
6.8.1 Setting of parameters	28
6.8.2 Perform the measurement.....	29
7 MANAGEMENT OF MEMORY DATA	30
7.1 Saving, recall and clear measurement results	30
8 CONNECTION OF THE INSTRUMENT TO PC	31
8.1 Installation of software and initial configurations (Win XP)	31
9 MAINTENANCE	33
9.1 General information.....	33
9.2 Replacement and charging batteries	33
9.3 Cleaning the instrument	33
9.4 End of life.....	33
10 TECHNICAL SPECIFICATIONS	34
10.1 Safety standards	35
10.2 General characteristics.....	36
10.3 Environment	36
10.4 Accessories	36
11 SERVICE	37
11.1 Warranty conditions.....	37
11.2 Service.....	37

1 PRECAUTIONS AND SAFETY MEASURES

The instrument has been designed in compliance with standards IEC/EN61557-1 and IEC/EN61010-1 regarding electronic measuring instruments



CAUTION

For the operator's safety and to prevent damaging the instrument, follow the procedures described in this manual and carefully read all notes preceded by the symbol 

Before and during measurements, carefully observe the following instructions:

- Do not perform any measurement in humid environments, in the presence of gas or explosive or inflammable material or in dusty areas
- Even when no measurements are being performed, avoid any contact with the circuit being tested, with exposed metal parts, with unused measuring leads or circuits, etc
- Do not perform any measurement when anomalies are found in the instrument, such as deformations, breaks, substance leaks, no display view, etc
- Pay special attention when measuring voltages above 25V in special environments (building yards, swimming pools, etc.) and 50V in ordinary environments, as there is the danger of electric shocks

In this manual and on the instrument, the following symbols are used:



WARNING: Observe the instructions reported in the manual. An improper use could damage the instrument and lead to dangerous situations for the operator



DC voltage or current



Dangerous voltages: risk of electric shocks



Instrument with double insulation

1.1 PRELIMINARY INSTRUCTIONS

- This instrument has been designed for use in an environment with pollution level 2
- It may also be used to test industrial electrical systems up to CAT IV 600V to earth with maximum voltage 600V between inputs
- Follow the usual safety rules to protect the operator from dangerous currents and protect the instrument against improper use
- Never use the instrument resting on the floor, it must be placed over flat horizontal surfaces
- Only the accessories supplied with the instrument guarantee safety standards. They must be in good conditions and replaced, if necessary, with identical models
- Do not measure systems exceeding the current and voltage limit values specified
- Do not perform measurements in environmental conditions not within the limit values indicated in this manual
- Before connecting the probes to the circuit to be tested, check that the correct function is selected

1.2 DURING USE

Carefully read the following recommendations and instructions:



CAUTION

Failure to observe the warnings and/or instructions may damage the instrument and/or its components or generate a danger for the operator. If, during use, the low battery symbol appears on the display, insert the supply cable into the Europlug socket to start battery recharge. During battery recharge, it is possible to perform measurements

- Before selecting a new function, disconnect the measuring probes from the circuit
- When the instrument is connected to the circuit being tested, never touch any unused lead
- Avoid measuring resistance with external voltages. Even if the instrument is protected, as an excess voltage may cause instrument malfunctions
- In case of a capacitive test object (long tested cable etc.), automatic discharge of the object may not be done immediately after finishing the measurement – “Please wait, discharging” message will be displayed
- Handling with capacitive loads note that 40nF charged to 1kV or 5nF charged to 10 kV are hazardous live

1.3 AFTER USE

When measurements are completed, turn off the instrument by pressing the ON/OFF key

1.4 DEFINITION OF MEASUREMENT (OVERVOLTAGE) CATEGORY

Standard "IEC/EN61010-1: Safety requirements for electrical equipment for measurement, control and laboratory use, Part 1: General requirements", defines what is intended for measurement category, commonly known as overvoltage category. In § 6.7.4: Measuring circuits, it reads:

Circuits are divided into the following measurement categories:

- **Measurement category IV** is for measurements performed at the source of a low-voltage installation
Examples are electric counters and measurements on primary devices protecting against overcurrents and on ripple adjusting units
- **Measurement category III** is for measurements performed on installations inside buildings
Examples are measurements performed on distribution boards, circuit breakers, wiring harnesses, including cables, bars, junction boxes, switches, sockets of fixed installations and appliances designed for industrial use and other equipment, e.g. stationary motors connected to fixed systems
- **Measurement category II** is for measurements performed on circuits directly connected to the low-voltage installation
Examples are measurements performed on household appliances, portable tools and similar equipment
- **Measurement category I** is for measurements performed on circuits not directly connected to the MAINS
Examples are measurements performed on circuits not derived from the MAINS and on circuits derived from the MAINS provided with a special (internal) protection. In this latter case, the stress caused by the transients is variable; therefore, (OMISSIS) it is necessary that the user knows the appliance's resistance to transients

2 GENERAL DESCRIPTION

The instrument HT7052 You purchased, if used in compliance with the indications given in this manual, guarantees accurate and reliable measurements and the utmost safety thanks to a development of new conception which ensures double insulation and, consequently, compliance with the requirements of overvoltage category IV

2.1 INSTRUMENT FEATURES

- High insulation resistance measurement up to 10 T Ω
 - Programmable test voltage from 500V up to 10 kV, step 25 V
 - R(t) Graphs
 - Programmable timer (1s up to 30 min)
 - Automatic discharge of test object after completion of measurement
 - Capacitance measurement
- Insulation resistance measurement with step-up voltage test
 - Five discrete test voltages proportionately set within preset test voltage range
 - Programmable timer 1 min up to 30 min per step
- Polarization Index (PI), Dielectric Absorption ratio (DAR) and Dielectric Discharge (DD) ratio measurements
 - $PI = R_{ins}(t2) / R_{ins}(t1)$
 - $DAR = R_{1min} / R_{15s}$
 - $DD = I_{dis1min} / C \cdot U$
- Withstanding voltage (DC) up to 10 kV
 - Programmable ramp test voltage from 500 V up to 10 kV
 - High resolution ramp (approx. 25 V per step)
 - Programmable threshold current up to 5mA
- Voltage and frequency measurement up to 600 V AC/DC

A dot matrix LCD offers easy-to-read results and all associated parameters. The operation is straightforward and clear to enable the user to operate the instrument without the need for special training (except reading and understanding this user manual)

Test results can be stored on the instrument. The new professional PC SW enables straightforward transfer of test results and other parameters in both directions between the test instrument and PC

3 PREPARATION FOR USE

3.1 INITIAL INSPECTIONS

Before shipment, the instrument's electronics and mechanics have been inspected. All possible precautions have been taken in order for the instrument to be delivered without damage

However, we recommend generally inspecting the instrument in order to detect any damage suffered during transport. Should you detect any anomalies, immediately contact the forwarding agent or the dealer

Moreover, we recommend checking that the package contains all parts listed in § 10.4. Should you find any discrepancy, please contact the dealer. Should it become necessary to return the instrument, please follow the instructions reported in § 11

3.2 INSTRUMENT POWER SUPPLY

The instrument is power-supplied through 6x1.2V IEC LR20 NiMH internal rechargeable batteries which are recharged from the mains by means of a battery charger integrated in the instrument itself. The symbol "" illuminated in the left bottom part indicates that the batteries are flat and must be recharged. To recharge or replace the batteries, follow the instructions given in § 10.2



CAUTION

- **Use only NiMH rechargeable batteries (IEC LR20)**
- Connect the instrument to the mains power supply for **20 hours** to fully charge batteries (typical charging current is 600mA). When you charge the batteries for the first time, it normally takes about 3 charge and discharge cycles for the batteries to regain full capacity

3.3 CALIBRATION

The instrument complies with the technical specifications reported in this manual. Its correct operation is guaranteed for one year from the date of purchase

3.4 STORAGE

In order to guarantee accurate measurements and protect the instrument from possible failures, after a long storage period under extreme environmental conditions, wait for the instrument to return to a normal condition (see the environmental specifications listed in § 0)

4 DESCRIPTION OF PARTS

4.1 INSTRUMENT DESCRIPTION

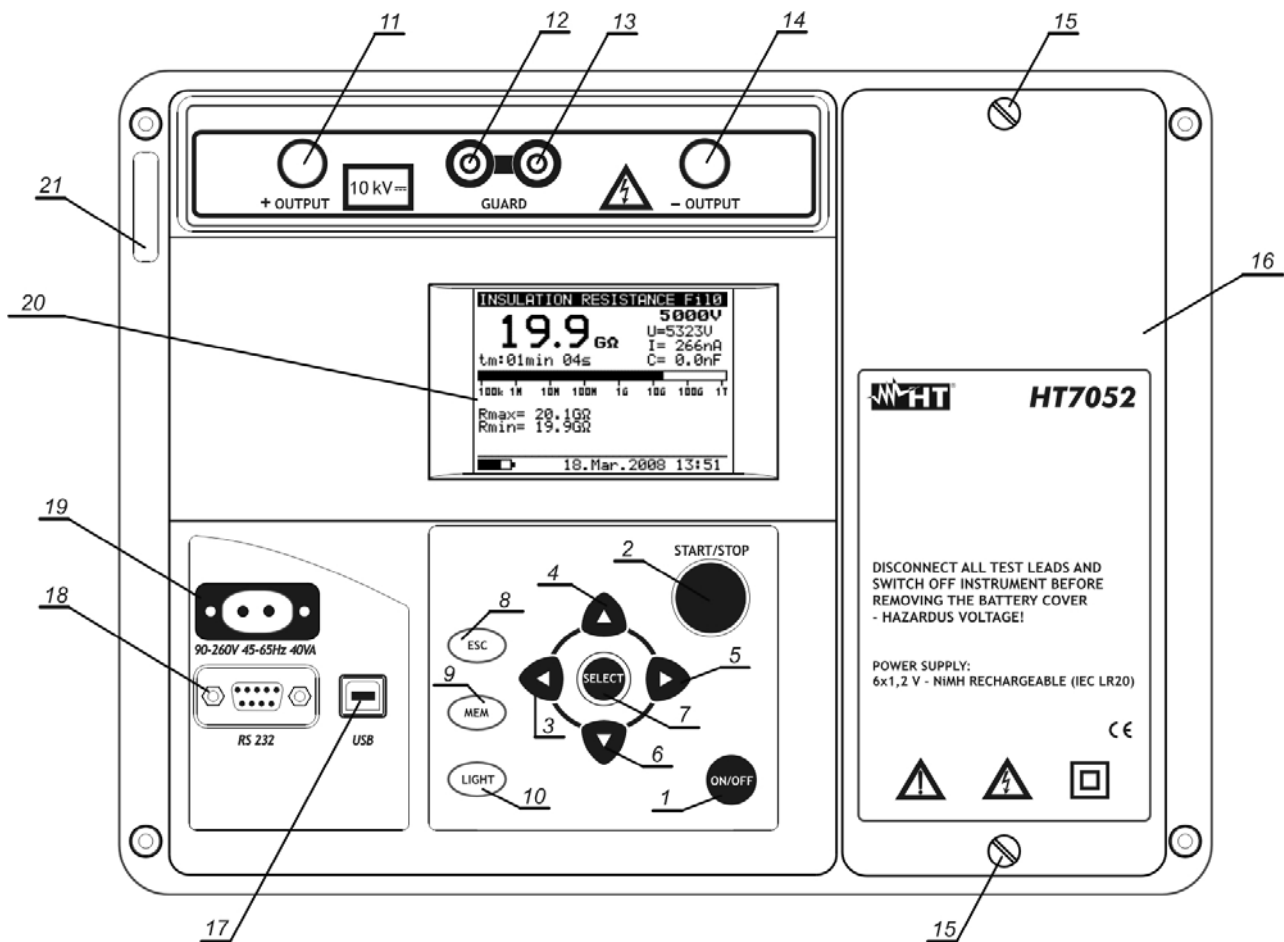

Fig. 1: Instrument description

LEGEND:

- 1 **ON/OFF** key to switch the instrument ON or OFF
- 2 **START/STOP** key to start or stop any measurement
- 3-4-5-6 **◀, ▲, ▶, ▼** arrow keys to select parameters and set values
- 7 **SELECT** key to enter set-up mode parameters
- 8 **ESC** key to exit the selected mode
- 9 **MEM** key to store, recall and erase results
- 10 **Light** key to turn the display backlight ON or OFF
- 11 Positive insulation resistance test terminal **+OUTPUT**
- 12 -13 **GUARD** test terminals intended to lead away potential leakage current
- 14 Negative insulation resistance test terminal **-OUTPUT**
- 15 Screw to fixing battery cover
- 16 Battery cover
- 17 USB galvanic port for connection to PC
- 18 RS-232 galvanic port for connection to PC
- 19 Mains connector to connect the instrument to the mains supply
- 20 LCD display
- 21 Label with serial number of the instrument

4.2 DESCRIPTION OF TEST LEADS

Test lead 1



This test lead is designed for hand held testing of insulation resistance

Features

- Shielded cable in order to increase the immunity to external disturb and improve the accuracy of measurements
- Insulation of yellow shielded cable: 12kVDC
- Length cable = 2m
- Test lead with double insulation and protection 10kVDC
- Red banana connector with basic protection 10kVDC and double protection 5kVDC
- Green guard banana connector: CAT IV 600V

Test leads 2

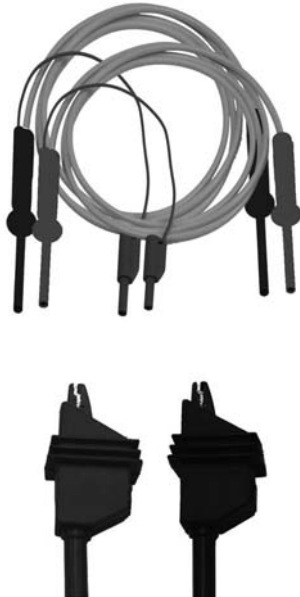

These test leads is designed for diagnostic testing of insulation

Features

- Shielded cables in order to increase the immunity to external disturb and improve the accuracy of measurements
- Insulation of yellow shielded cables: 12kVDC
- Length cables = 2m
- Red/black banana connectors with basic protection 10kVDC and double protection 5kVDC
- Green guard banana connectors: CAT IV 600V
- Red/Black alligator clips with basic protection 10kVDC and double protection 5kVDC

Guard test lead



This test lead is used in connection with the object on test in order to reduce or cancel the surface leakage current (see § 6.2)

Features

- Cable banana-banana with protection CAT IV 600V
- Alligator clip CAT IV 600V

5 INITIAL OPERATIONS

5.1 SWITCHING ON THE INSTRUMENT

5.1.1 Mains powered instrument operation



CAUTION

- If you connect instrument to the mains supply when instrument is turned OFF, internal charger will begin to charge the batteries but instrument will remain turned OFF. In button left angle of LCD, flashing battery indicator will appear to indicate that the batteries are charging
- **If batteries are defective or missing and the instrument is connected to the mains, the instrument do not switch on**
- **If batteries are defective or missing, the charger will not work. In button left corner of LCD screen only plug character will be appeared**
- If the instrument is connected to the mains supply when the instrument is turn ON, the instrument will automatically switch from the battery supply to the main supply. In button left corner of the LCD screen, the plug character will appear
- If instrument is not in measuring mode*, the internal charger will begin to charge the batteries. In button left corner of LCD screen battery indicator will start to flash, indicating that the batteries are charging
- It is recommended to DO NOT connect or disconnect the instrument to mains supply while the instrument is in measuring mode

5.1.2 Backlight operation

Instrument supplied by the batteries

After turning the instrument ON the LCD backlight is automatically turned ON. It can be turned OFF and ON by simply clicking the **LIGHT** key

Instrument supplied by the mains

After turning the instrument ON the LCD backlight is automatically turned OFF. It can be turned OFF and ON by simply clicking the **LIGHT** key

Auto power OFF

The instrument can be switched OFF only by pressing the **ON/OFF** key. The auto-off function is not available to allow long-term measurements to be performed

5.1.3 Autocalibration

The instrument is switched ON by pressing the **ON/OFF** key. After turning on, the instrument will perform the autocalibration (see Fig. 3). Measuring test leads should be disconnected during autocalibration. If not, the autocalibration procedure could be false and instrument will require disconnection of the test leads and repeat switching OFF and ON



Fig. 2: Splash screen

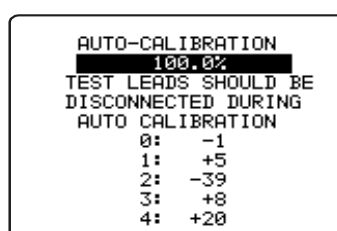

Fig. 3: Autocalibration

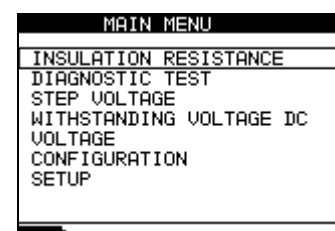

Fig. 4: Main menu

After finishing the autocalibration, the main menu (see Fig. 4) will appear and instrument is ready for normal operation

Auto-calibration prevents the reduction in accuracy when measuring very low currents. It compensates the effects caused by ageing, temperature and humidity changes etc. A new auto-calibration is recommended when the temperature changes by more than 5°C. If the instrument detects an incorrect state during the autocalibration, the following warning message will be displayed:



CAUTION

- TEST LEADS CONNECTED: DISCONNECT AND SWITCH ON THE INSTRUMENT AGAIN
- CONDITIONS OUT OF RANGE: PRESS START TO CONTINUE

Possible reasons for out of range conditions are excessive humidity, excessively high temperature, etc. In this case it is possible to perform measurements by pressing the **START/STOP** button again but results could be out of technical specification

5.2 CONFIGURATION AND SETUP OF SYSTEMS PARAMETERS

The configuration and setup function enables the selection and adjustment of the parameters (see Table 1) that are not directly involved in the measurement procedure (see Fig. 5 and Fig. 6). In the lower section of the display the power supply status is shown



Fig. 5: Configuration menu

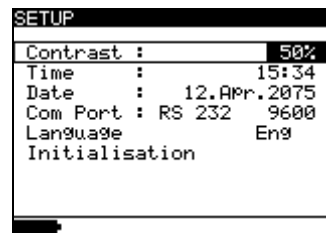

Fig. 6: Setup menu

PARAMETERS	VALUE	DESCRIPTION
Memory clear		Clear all memory locations
Filter	Fil1, Fil2, Fil3, Fil0	Selection of noise rejecting filter (see § 6.3)
DIAG. Starting time	0%...90%	Adjustment of start of the timer in the DIAGNOSTIC TEST functions, according to the nominal voltage Unominal. See additional explanation in § 6.1)
Contrast	0%...100%	Adjustment of the LCD contrast
Time		Set real time (hour: minute)
Date		Set current date (day-month-year)
COM port	RS232 2400, RS232 4800, RS232 9600, RS232 19200, USB 115000	Set communication mode and rate
Language	Ita, Eng, Esp, Deu	Set system language
Initialization		For internal factory and service maintenance only

Table 1: Configuration of system parameters

1. Use ▲ and ▼ arrows to select parameter (line) to be adjusted
2. Use ► or ◀ arrows to change the value of the selected parameter. If there are two or more sub-parameters in one line (e.g. date and time) then use the **SELECT** key to skip to the next sub-parameters and back
3. Press the **ESC** key to exit from configuration and back to the main menu

6 HOW TO PERFORM THE MEASUREMENTS

6.1 THEORY OF INSULATION RESISTANCE MEASUREMENT

The purpose of insulation tests

Insulating materials are important parts of almost every electrical product. The material's properties depend not only on its compound characteristics but also on temperature, pollution, moisture, ageing, electrical and mechanical stress, etc. Safety and operational reliability require the regular maintenance and testing of the insulation material to ensure it is kept in good operational condition. High voltage tests are used to test insulating materials

DC vs. AC testing voltage

Testing with a DC voltage is widely accepted as being useful as testing with AC and / or pulsed voltages. DC voltages can be used for breakdown tests especially where high capacitive leakage currents interfere with measurements using AC or pulsed voltages. DC is mostly used for insulation resistance measurement tests. In this type of test, the voltage is defined by the appropriate product application group. This voltage is lower than the voltage used in the withstanding voltage test so the tests can be applied more frequently without stressing the test material

Typical insulation tests

In general, insulation resistance tests consist of the following possible procedures:

- Simple insulation resistance measurement also called a spot test
- Measurement of the relationship between voltage and insulation resistance
- Measurement of the relationship between time and insulation resistance
- Test of residual charge after the dielectric discharge

The results of this test can indicate whether the replacement of the insulation system is required. Typical examples of where testing insulation resistance and its diagnosis are recommended are transformer and motor insulation systems, cables and other electrical equipment

Electrical representation of insulating material

The represents the equivalent electrical circuit of an insulating material

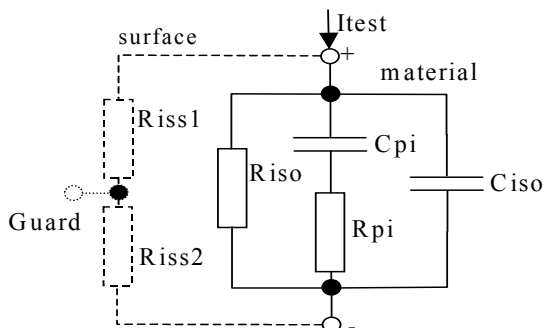

Fig. 7: Equivalent electrical circuit

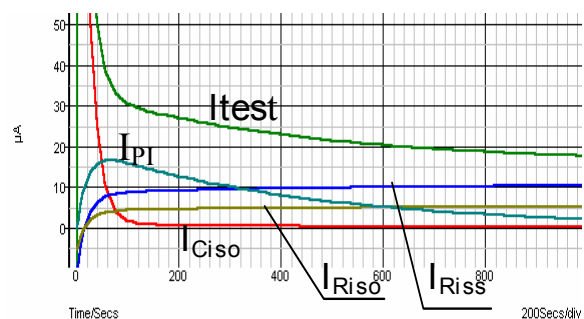

Fig. 8: Current graphs

R_{iss1}, R_{iss2} = surface resistivity (position of optional guard connection)

R_{iso} = the actual insulation resistance of material

C_{iso} = capacitance of material

C_{pi}, R_{pi} = represents polarization effects

The Fig. 8 shows typical currents for that circuit, where:

I_{test} = overall test current ($I_{test} = I_{PI} + I_{RISO} + I_{RISS}$)

I_{PI} = polarization absorption current

I_{RISO} = actual insulation current

I_{RISS} = surface leakage current

Basic Insulation resistance test

Virtually every standard concerning the safety of electrical equipment and installations requires the performance of a basic insulation testing. When testing lower values (in the range of $M\Omega$), the basic insulation resistance (R_{iso}) usually dominates. The results are adequate and stabilize quickly

It is important to remember the following:

- The voltage, time and limit are usually given in the appropriate standard or regulation
- Measuring time should be set to 60 s or the minimum time required for the Insulation capacitance C_{iso} to be charged up
- Sometimes it is required to take ambient temperature into account and adjust the result for a standard temperature of $40^{\circ}C$

If surface leakage currents interfere with the measurements (see R_{iss} above) use the guard connection (see § 5.2.). This becomes critical when measured values are in the $G\Omega$ range

Voltage dependence test – Step voltage test

This test shows if the insulation under test has been electrically or mechanically stressed. In this instance the quantity and size of insulation anomalies (e.g. cracks, local breakdowns, conductive parts, etc). is increased and the overall breakdown voltage is reduced. Excessive humidity and pollution have an important role especially in the case of mechanical stress. If the results of successive tests show a reduction in the tested insulation resistance the insulation should be replaced

In this function the instrument measure the insulation resistance by considering 5 equal time intervals with the test voltage divided from 1/5 of nominal value to the set nominal value (see Fig. 9)

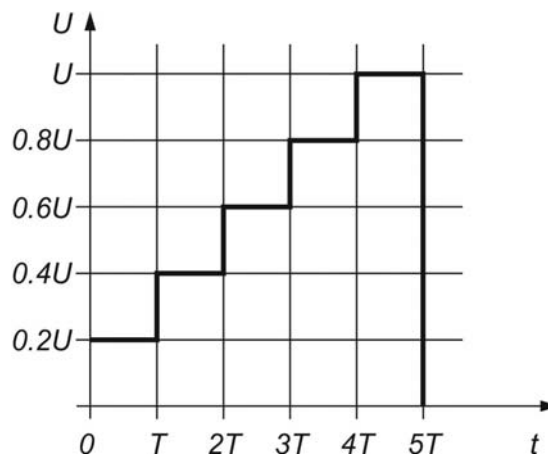

Fig. 9: Insulation measurement with step voltage test

6.1.1 Time dependence test – Diagnostic test

Diagnostic test is a long duration test for evaluating the quality of the insulation material under test. The results of this test enable the decision to be made on the preventive replacement of the insulation material

DIELECTRIC ABSORPTION RATIO (DAR)

DAR is ratio of Insulation Resistance values measured after 15s and after 1 minute. The DC test voltage is present during the whole period of the test (also an Insulation Resistance measurement is continually running). At the end, the DAR ratio is displayed:

$$DAR = \frac{R_{iso}(1min)}{R_{iso}(15s)}$$

Some applicable values:

DAR value	Tested material status
< 1.25	Not acceptable
< 1.6	Considered as good insulation
> 1.6	Excellent

When determining R_{iso} (15s) pay attention to the capacitance of the test object. It has to be charged-up in the first time section (15s). Approximate maximum capacitance using:

$$C_{max} [\mu F] = \frac{t [s] 10^3}{U [V]}$$

where:

t = period of first time unit (e.g. 15s)

U = test voltage.

To avoid this problem, increase the **DIAG. Starting time** parameter in CONFIGURATION menu, because start of timer in the DIAGNOSTIC TEST functions depends on the test voltage. The timer begins to run when test voltage reaches the threshold voltage, which is product of the **DIAG. Starting time** and nominal test voltage (**Unominal**)

Using filters (fil1, fil2, fil3) in the DAR function is not recommended!

Analysing the change in the measured insulation resistance over time and calculating the DAR and PI are very useful maintenance tests of an insulating material

POLARIZATION INDEX (PI)

PI is the ratio of Insulation Resistance values measured after 1 minute and after 10 minutes. The DC test voltage is present during the whole period of the measurement (an Insulation Resistance measurement is also running). On completion of the test the PI ratio is displayed:

$$PI = \frac{R_{iso}(10 \text{ min})}{R_{iso}(1 \text{ min})}$$

General applicable values:

PI value	Tested material status
1 to 1.5	Not acceptable (older types)
2 to 4 (typically 3)	Considered as good insulation (older types)
>4(very high insulation resistance)	Modern type of (good) insulation systems

When determining R_{iso} (1min) pay close attention to the capacitance of the object under test. It has to be charged-up in the first time section (1 min). Approximate maximum capacitance using:

$$C_{\max} [\mu F] = \frac{t [s] 10^3}{U [V]}$$

where:

t = period of first time unit (e.g. 1min)

U = test voltage

To avoid this problem, increase the **DIAG. Starting time** parameter in CONFIGURATION menu, because start of timer in the DIAGNOSTIC TEST functions depends on the test voltage. The timer begins to run when test voltage reaches the threshold voltage, which is product of the **DIAG. Starting time** and nominal test voltage (**Unominal**)

DIELECTRIC DISCHARGE RATIO (DD)

An additional effect of polarization is the recovered charge (from Cpi) after the regular discharging of a completed test. This can also be a supplementary measurement for evaluation of the quality of insulating material. This effect is generally found in insulating systems with large capacitance Ciso. The polarisation effect (described in "Polarisation Index") causes a capacitance to form (Cpi). Ideally this charge would dissipate immediately a voltage was removed from the material. In practice, this is not the case

DD is the diagnostic insulation test carried out after the completion of the Insulation Resistance measurement. Typically the insulation material is left connected to the test voltage for 10 ÷ 30 min and then discharged before the DD test is carried out. After 1 minute a discharge current is measured to detect the charge re-absorption of the insulation material. A high re-absorption current indicates contaminated insulation (mainly based on moisture):

$$DD = \frac{I_{dis1\ min}[mA]}{U[V]C[F]}$$

where:

$I_{dis\ 1\ min}$ = discharging current measured 1 min after regular discharge

U = test voltage

C = capacitance of test object

General applicable values:

DD Value	Tested material status
> 4	Bad
2 - 4	Critical
< 2	Good

6.1.2 Withstanding voltage test

Some standards allow the use of a DC voltage as an alternative to AC withstanding voltage testing. For this purpose the test voltage has to be present across the insulation under test for a specific time. The insulation material only passes if there is no breakdown or flash over. Standards recommend that the test starts with a low voltage and reaches the final test voltage with a slope that keeps the charging current under the limit of the current threshold. The test duration normally takes 1 min

The instruments offers Withstanding Voltage test of insulation material. It covers two types of tests:

- Breakdown voltage testing of high voltage device, e.g. transient suppressors and
- DC withstanding voltage test for insulation coordination purposes

Both functions require breakdown current detection. The test voltage increases step by step from the Start up to the Stop value over a predefined time and it is kept at the Stop value for a predefined test time (see Fig. 10 – left part) or it happens the breakdown on device under test (see Fig. 10 – right part)

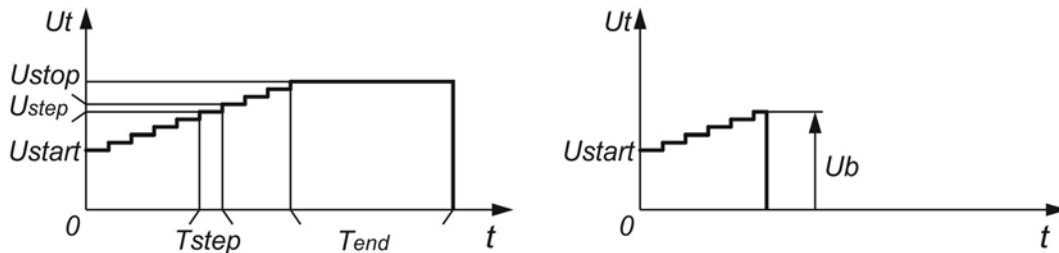

Fig. 10: Withstanding test without breakdown (left) and with breakdown (right)

U_t = test voltage

t = time

U_{start} = starting voltage

U_{step} = voltage step approx. 25 V (fixed value - not modify)

U_{stop} = end test voltage

T_{step} = test voltage duration per step

T_{end} = constant test voltage duration after reaching End value

U_b = breakdown voltage

Humidity and insulation resistance measurements

When testing outside the reference ambient conditions, the quality of the insulation resistance measurements can be affected by humidity. Humidity adds leakage paths onto the surface of the complete measuring system, (i.e. the insulator under test, the test leads, the measuring instrument etc). The influence of humidity reduces accuracy especially when testing very high resistances (e.g. $T\Omega$). The worst conditions arise in environments containing high condensation, which can also reduce safety. In the case of high humidity, it is recommended to ventilate the test areas before and during the measurements. In the case of condensed humidity the measuring system must dry and it can take several hours or even few days to recover

6.2 GUARD TERMINAL

The purpose of the GUARD terminal is to lead away potential leakage currents (e.g. surface currents), which are not a result of the measured insulation material itself but are a result of the surface contamination and moisture. This current interferes with the measurement i.e. the Insulation Resistance result is influenced by this current. The GUARD terminal is internally connected to the same potential as the negative test terminal (black one). The GUARDs test clip should be connected to the test object so as to collect most of the unwanted leakage current (see Fig. 11)

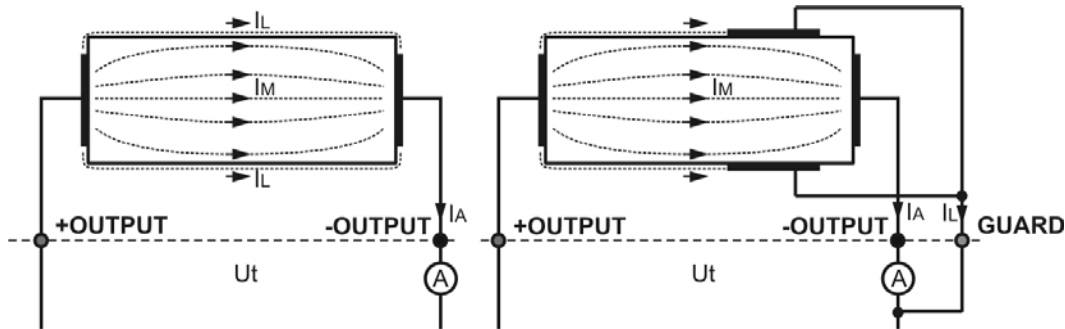

Fig. 11: Principle scheme relative to the Guard terminal

where:

U_t Test voltage

I_L Leakage current (resulted by surface dirt and moisture)

I_M Material current (resulted by material conditions)

I_A Test current

Result without GUARD terminal: $R_{INS} = U_t / I_A = U_t / (I_M + I_L) \rightarrow$ Incorrect result

Result using GUARD terminal: $R_{INS} = U_t / I_A = U_t / I_M \rightarrow$ correct result

The GUARD terminal it is internal connected at the same negative test lead (black). The alligator clip should be connected to the object on test in way to detect the most possible leakage current (see Fig. 12)

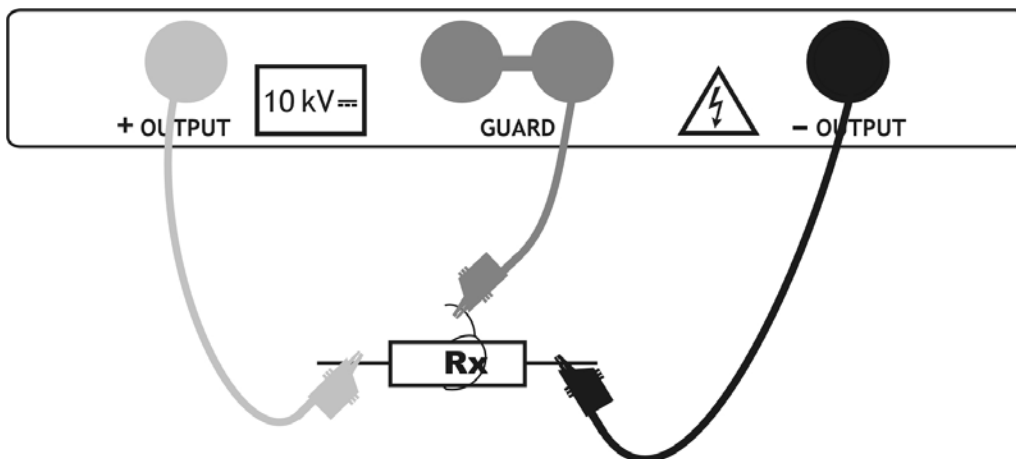

Fig. 12: Connection of the Guard terminal to the object on test

CAUTION



- It is recommended to use the GUARD connection when high insulation resistance ($> 10G\Omega$) should be measured
- The guard terminal is protected by an internal impedance $400k\Omega$
- The instrument has two guard terminals to allow easy connection of shielded measuring leads

6.3 USE OF INTERNAL FILTERS

Filters are built in to reduce the influence of noise on measurement results. This option enables more stable results especially when dealing with high Insulation Resistances (Insulation Resistance, Diagnostic Test, Step Voltage). In these functions, the status of the filter option is shown in the top right corner of the LCD screen. The below table contains a definition of the individual filter options

Filter options	Description
Fil0	Low pass filter with cut off frequency of 0.5 Hz in signal line
Fil1	Additional low pass filter with cut off frequency of 0.05 Hz in the signal line
Fil2	Fil1 with increased integrating time (4 s)
Fil3	Fil2 with additional cyclic averaging of 5 results

Table 2: Filter options

6.3.1 The purpose of filtering

The internal filters smooth the measured currents by means of averaging and bandwidth reduction. There are various sources of disturbance:

- AC currents at the mains frequency and its harmonics, switching transients etc, cause the results to become unstable. These currents are mostly cross talk through insulation capacitances close to live systems
- Other currents induced or coupled in the electromagnetic environment of the insulation under test
- Ripple current from internal high voltage regulator,
- Charging effects of high capacitive loads and / or long cables.

Voltage changes are relatively narrow on high resistance insulation, so the most important point is to filter the measured current



CAUTION

- Any of the selected filter options increases the settling time with Fil1 to 60 s, Fil2 to 70 s, and Fil3 to 120s
- It is necessary to pay close attention to the selection of time intervals when using the filters
- The recommended minimum measuring times when using filters are the settling times of the selected filter option

Example:

A noise current of 1mA/50Hz adds approximately $\pm 15\%$ distribution to the measured result when measuring 1G Ω .

- By selecting FIL1 option the distribution will reduce to less than $\pm 2\%$
- In general using FIL2 and FIL3 will further improve the noise reduction

6.4 VOLTAGE MEASUREMENT



CAUTION

Maximum input for DC or AC voltage is 600V. Do not attempt to take any voltage measurement that exceeds the limits. Exceeding the limits could cause electrical shock and damage the instrument

1. Switch on the instrument by pressing the **ON/OFF** key
2. Select with arrow keys **▼** or **▲** the item "VOLTAGE" on main menu and confirm with **SELECT** key. The screen of Fig. 13 is shown by the meter

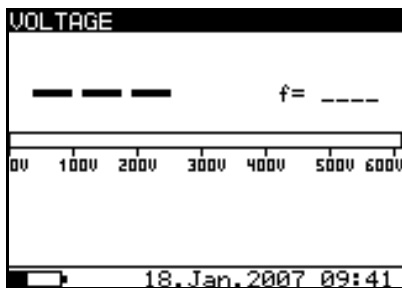

Fig. 13: Initial screen of voltage measure

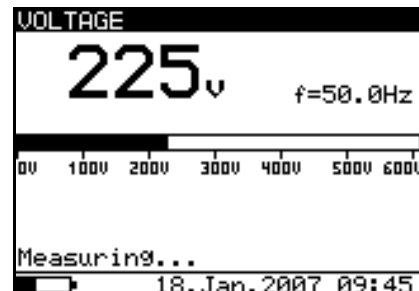

Fig. 14: Screen of measured value

3. Connect the red part of the Test lead 1 or Test leads 2 (see § 4.2) to the **+OUTPUT** input and the black part of the Test leads 2 (see § 4.2) to the **-OUTPUT** input
4. Connect the tip of Test lead 1 or Test leads 2 (positive) and the black cable of Test leads 2 (negative) to the object on test respect the polarities for DC voltage measurement (see Fig. 15)

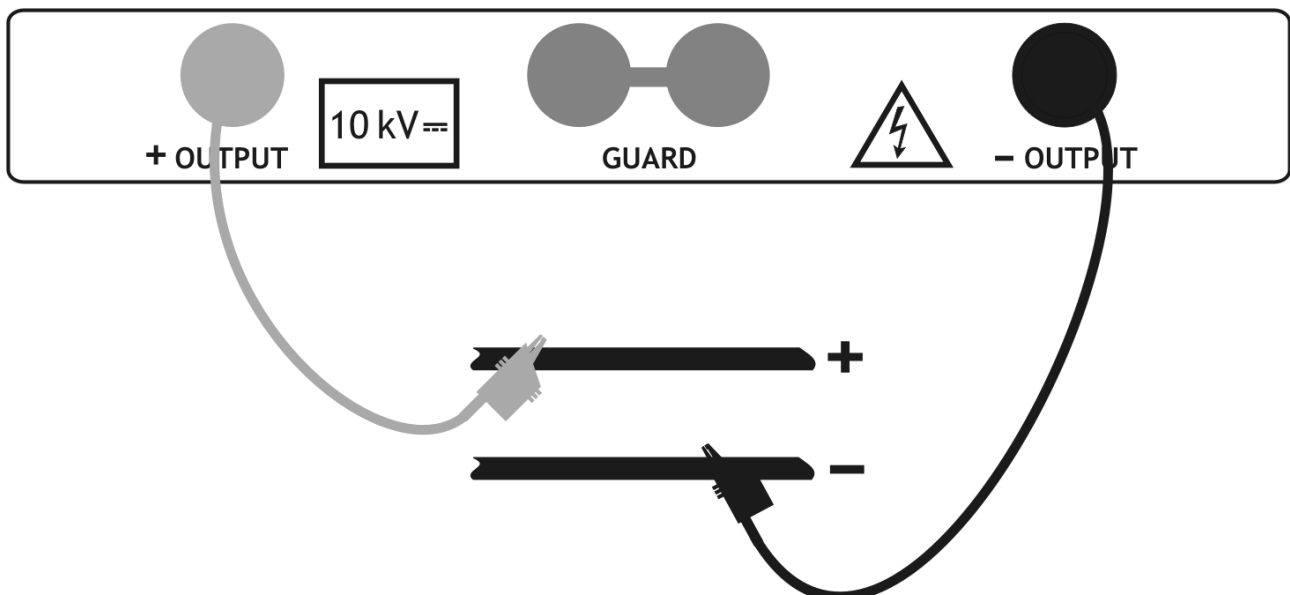

Fig. 15: Connection of meter for voltage measurement

5. Press **START/STOP** key to activate the measurement in continuous mode
6. Press again the **START/STOP** to stop the measurement. The result of test is shown at display (see Fig. 14)
7. For saving the result see § 7

6.5 INSULATION RESISTANCE MEASUREMENT

6.5.1 Setting of parameters

1. Switch on the instrument by pressing the **ON/OFF** key
2. Select with arrow keys **▼** or **▲** the item “INSULATION RESISTANCE” on main menu and confirm with **SELECT** key. The screen of Fig. 16 is shown by the meter. In case of activation of Graphic R(t) option press arrow keys **▼** or **▲** to select the graphical screen of Fig. 17

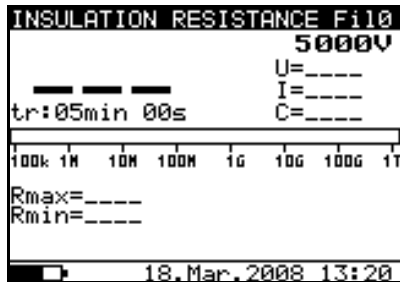

Fig. 16: Initial numerical screen

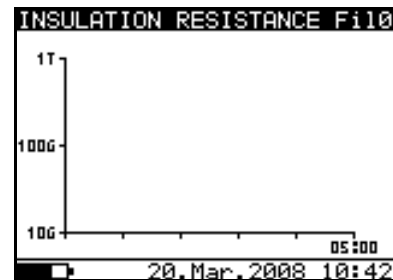

Fig. 17: Initial graphical screen

3. Press again the **SELECT** key to enter in the setup parameters section. The screen of Fig. 18 is shown by the meter
4. Use the arrow keys **▼** or **▲** for the selection of parameters. The herewith Table 3 shows the meaning of the measurement parameters
5. Set the values by using the arrow keys **◀** or **▶**. Press **SELECT** key to select possible sub-parameters and repeat the settings
6. To activate the graphical screen the parameter Graph R(t) should be ON and the Timer must be activated (see Fig. 18). The time duration of graphical function is correspondent to the value of set Timer
7. The Timer value could be very long (up to 30 minutes), so the special automatic decimation algorithm (LOG) is use to write the Graph R(t) at display (see Fig. 19)
8. The cursors of the Graph R(t) could be activated with **◀** key at the end of measurement. The cursors of the Graph R(t) could be moved with **◀** or **▶** keys
9. Press **ESC** key to save the settings and back to the measurement screen or the **START/STOP** key to exit from the settings menu and activate the test

Parameter	Description
Unominal	Set test voltage – Range 500V÷10kV step 25V
Timer	Duration of the measurement
Timer ON/OFF	ON: timer activated, OFF timer disabled
Time 1	Time to accept and display first Rmin and Rmax results
Graph R(t)	Enable/Disable Graph R(t)
R(t)	Set of minimum and maximum values of R(t) for graphical screen
R(t) Type	Set of “LIN” (linear) o “LOG” algorithm of graphical screen

Table 3: Setting of internal parameters



CAUTION

Timer and Time1 are independent timers. Maximum time for each of them is **30 min 60s**

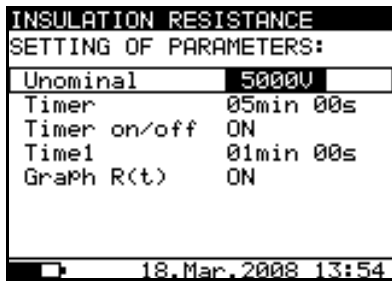

Fig. 18: Setting parameters

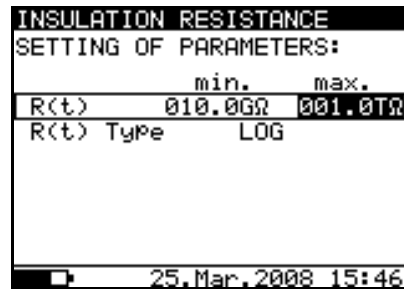

Fig. 19: Setting of graph R(t) parameters

6.5.2 Perform the measurement

1. Switch on the instrument by pressing the **ON/OFF** key
2. Select with arrow keys \blacktriangledown or \blacktriangle the item "INSULATION RESISTANCE" on main menu and confirm with **SELECT** key. The screen of Fig. 20 is shown by the meter. In case of activation of Graphic R(t) option press arrow keys \blacktriangledown or \blacktriangle to select the graphical screen of Fig. 22



CAUTION

It is not possible to switching mode of presentation when measurement running

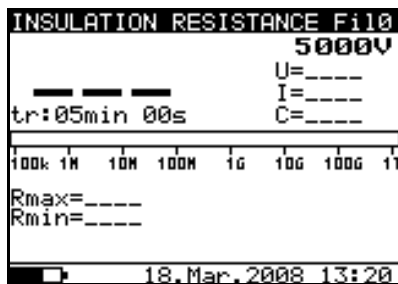

Fig. 20: Initial numerical screen

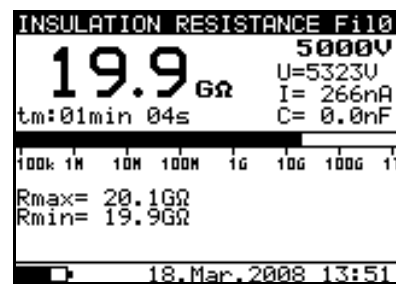

Fig. 21: Numerical screen of result

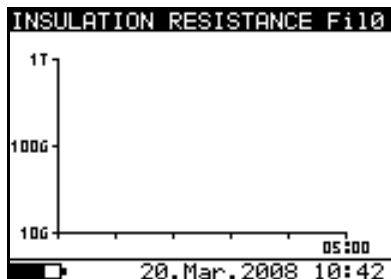

Fig. 22: Initial graphical screen

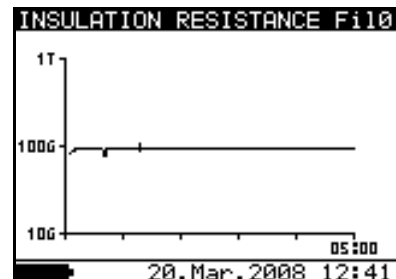

Fig. 23: Graphical screen of result

3. Connect the red part of the Test lead 1 or Test leads 2 (see § 4.2) to the **+OUTPUT** input and the black part of the Test leads 2 (see § 4.2) to the **-OUTPUT** input
4. Connect the tip of Test lead 1 or Test leads 2 (positive) and the black cable of Test leads 2 (negative) to the object on test (see Fig. 24)

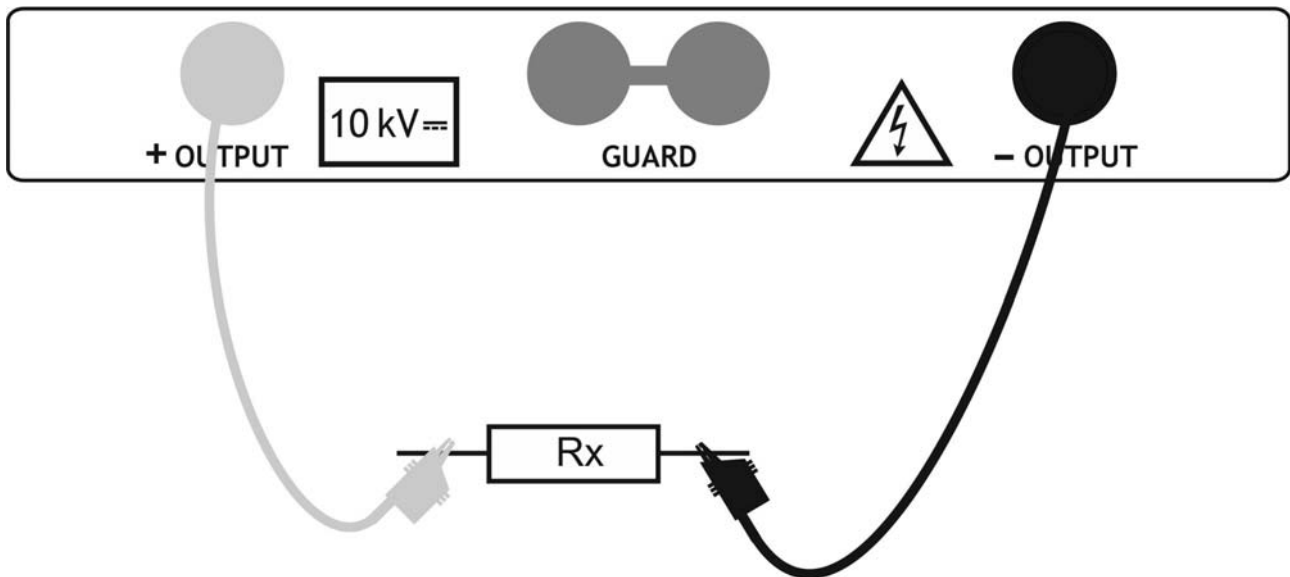

Fig. 24: Connection of instrument for insulation measurement

5. Press **START/STOP** key to activate the measurement in continuous mode
6. Wait for a stable result at display and press again **START/STOP** key to stop the measurement or wait for the end of the set Timer. The result of test is shown at display (see Fig. 21 or Fig. 23) with meaning of items described in Table 4
7. Wait for the object under test to discharge
8. For saving the result see § 7

Parameter at display	Description
Fil0 (Fil1, Fil2, Fil3)	Filter type enabled, see the chapter 5.3. Configuration (see § 6.3)
5000V	Set test voltage
U=5323V	Applied test voltage
I=266nA	Applied test current
19.9GΩ	Result of insulation measurement
C=0.0nF	Capacitance of measured object
Tm:01min 04s	Timer information – test duration
Bargraph	Analogue representation of result
Rmax=20.GΩ	Maximum value of result (only if timer is enabled)
Rmin=19.9GΩ	Minimum value of result (only if timer is enabled)

Table 4: Meaning of parameters of insulation measurement

CAUTION



- If the timer is disabled then **OFF** is displayed instead of the timer value
- During a measurement, the timer information displays the time needed to complete the measurement (t_r) while after the completion the test duration (t_m) is displayed
- A high-voltage warning symbol appears on the display during the measurement to warn the operator of a potentially dangerous test voltage
- Value of capacitance is measured during the final discharge of the test object

6.6 DIAGNOSTIC TEST

6.6.1 Setting of parameters

1. Switch on the instrument by pressing the **ON/OFF** key
2. Select with arrow keys ▼ or ▲ the item “DIAGNOSTIC TEST” on main menu and confirm with **SELECT** key. The screen of Fig. 25 is shown by the meter. In case of activation of Graphic R(t) option press arrow keys ▼ or ▲ to select the graphical screen of Fig. 26

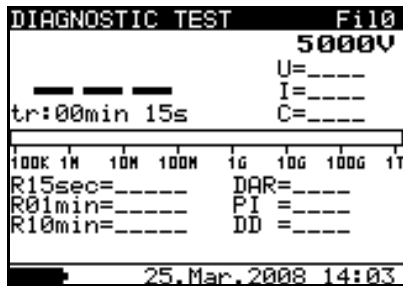

Fig. 25: Initial numerical screen

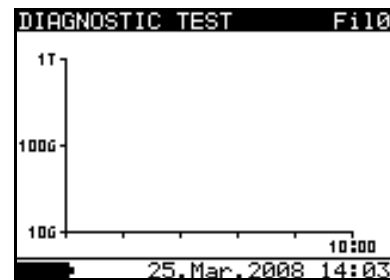

Fig. 26: Initial graphical screen

3. Press again the **SELECT** key to enter in the setup parameters section. The screen of Fig. 27 is shown by the meter
4. Use the arrow keys ▼ or ▲ for the selection of parameters. The herewith Table 3 shows the meaning of the measurement parameters
5. Set the values by using the arrow keys ◀ or ▶. Press **SELECT** key to select possible sub-parameters and repeat the settings
6. To activate the graphical screen the parameter Graph R(t) should be ON and the Timer must be activated (see Fig. 27). The time duration of graphical function is correspondent to the value of set Time3
7. The Timer value could be very long (up to 30 minutes), so the special automatic decimation algorithm (LOG) is use to write the Graph R(t) at display (see Fig. 28)
8. The cursors of the Graph R(t) could be activated with ◀ key at the end of measurement. The cursors of the Graph R(t) could be moved with ◀ or ▶ keys
9. Press **ESC** key to save the settings and back to the measurement screen or the **START/STOP** key to exit from the settings menu and activate the test

Parameter	Description
Unominal	Set test voltage – Range 500V±10kV step 25V
Time1	Time to take R1min result
Time2	Time to take R1min result and calculate DAR
Time3	Time to take R3min result and calculate PI
DD ON/OFF	ON: DD enabled, OFF: DD disabled
Graph R(t)	Enable/Disable Graph R(t)
R(t)	Set of minimum and maximum values of R(t) for graphical screen
R(t) Type	Set of “LIN” (linear) o “LOG” algorithm of graphical screen

Table 5: Setting of internal parameters



CAUTION

Time1 ≤ Time2 ≤ Time3 are timers with the same start point. The value of each presents the duration from the start of the measurement. The maximum time is **30 min**

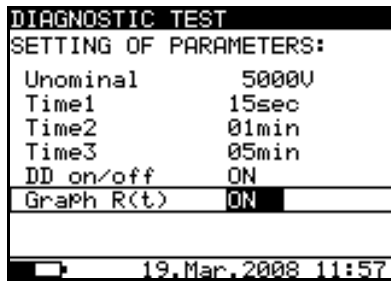

Fig. 27: Setting parameters

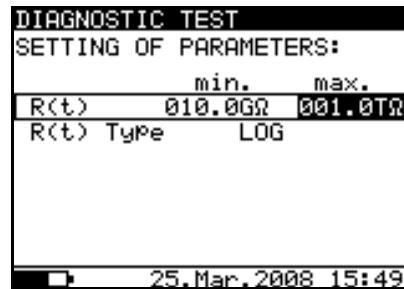

Fig. 28: Setting of graph R(t) parameters

6.6.2 Perform the measurement

1. Switch on the instrument by pressing the **ON/OFF** key
2. Select with arrow keys **▼** or **▲** the item “DIAGNOSTIC TEST” on main menu and confirm with **SELECT** key. The screen of Fig. 29 is shown by the meter. In case of activation of Graphic R(t) option press arrow keys **▼** or **▲** to select the graphical screen of Fig. 31



CAUTION

It is not possible to switching mode of presentation when measurement running

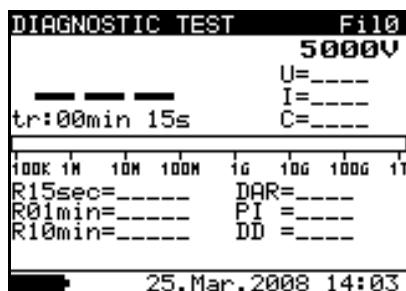

Fig. 29: Initial numerical screen

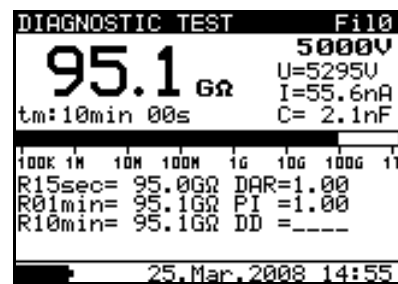

Fig. 30: Numerical screen of result

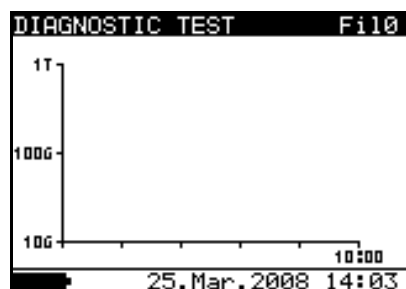

Fig. 31: Initial graphical screen

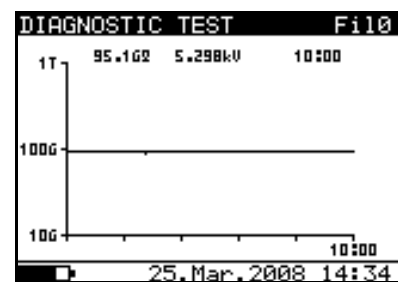

Fig. 32: Graphical screen of result

3. Connect the red part of the Test lead 1 or Test leads 2 (see § 4.2) to the **+OUTPUT** input and the black part of the Test leads 2 (see § 4.2) to the **-OUTPUT** input. In case of use of GUARD terminals (see § 6.2) connect also the green cables to the “GUARD” input (see Fig. 33)
4. Connect the tip of Test lead 1 or Test leads 2 (positive) and the black cable of Test leads 2 (negative) to the object on test (see Fig. 33)

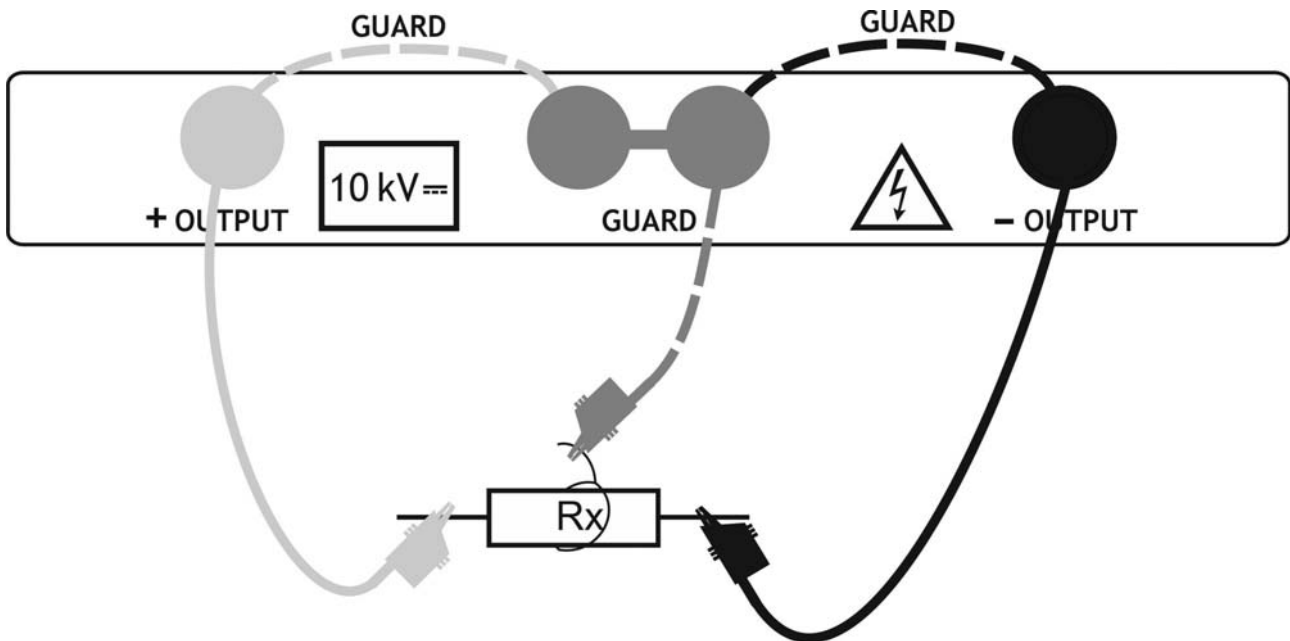

Fig. 33: Connection of instrument for diagnostic test

5. Press **START/STOP** key to activate the insulation measurement
6. Wait for the end of the set Timers. The result of test is shown at display (see Fig. 30 or Fig. 32) with meaning of items described in Table 6
7. Wait for the object under test to discharge
8. For saving the result see § 7

Parameter at display	Description
Fil0 (Fil1, Fil2, Fil3)	Filter type enabled on test (see § 6.3)
5000V	Set test voltage – step 25 V
U=5295V	Applied test voltage
I=55.6nA	Applied test current
95.1GΩ	Result of insulation measurement
C=2.1nF	Capacitance of measured object
Bargraph	Analogue representation of Riso result
R15sec=95.0GΩ	Resistance value measured after set time 1
R01min=95.1GΩ	Resistance value measured after set time 2
R10min=95.1GΩ	Resistance value measured after set time 3
DAR=1.00	DAR as ratio of R1min / R15s
PI=1.00	PI as ratio of R10min/R1min
DD=	DD result

Table 6: Meaning of parameters of diagnostic test



CAUTION

- A high-voltage warning symbol appears on the display during the measurement to warn the operator of a potentially dangerous test voltage
- The value of the capacitance is measured during the final discharge of the test object
- If enabled, the instrument measures Dielectric Discharge (DD) when the capacitance is in the range **5nF ÷ 50μF**

6.7 INSULATION RESISTANCE WITH STEP VOLTAGE TEST

6.7.1 Setting of parameters

1. Switch on the instrument by pressing the **ON/OFF** key
2. Select with arrow keys **▼** or **▲** the item “STEP VOLTAGE” on main menu and confirm with **SELECT** key. The screen of Fig. 34 is shown by the meter. In case of activation of Graphic R(t) option press arrow keys **▼** or **▲** to select the graphical screen of Fig. 35

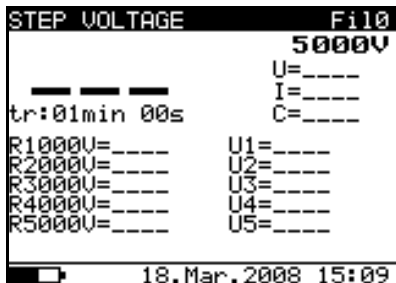

Fig. 34: Initial numerical screen

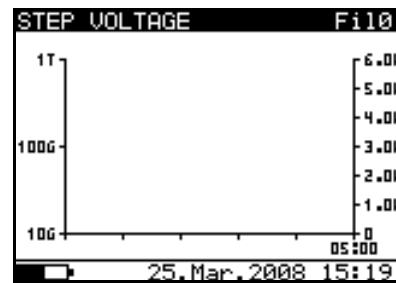

Fig. 35: Initial graphical screen

3. Press again the **SELECT** key to enter in the setup parameters section. The screen of Fig. 36 is shown by the meter
4. Use the arrow keys **▼** or **▲** for the selection of parameters. The herewith Table 7 shows the meaning of the measurement parameters
5. Set the values by using the arrow keys **◀** or **▶**. Press **SELECT** key to select possible sub-parameters and repeat the settings
6. To activate the graphical screen the parameter Graph R(t) should be ON and the Timer must be activated (see Fig. 36). The time duration of graphical function is correspondent to the value of Step Timer multiplied by 5
7. The Timer value could be very long (up to 150 minutes), so the special automatic decimation algorithm (LOG) is use to write the Graph R(t) at display (see Fig. 37)
8. The cursors of the Graph R(t) could be activated with **◀** key at the end of measurement. The cursors of the Graph R(t) could be moved with **◀** or **▶** keys
9. Press **ESC** key to save the settings and back to the measurement screen or the **START/STOP** key to exit from the settings menu and activate the test

Parameter	Description
Unominal	Set test voltage – Range 2kV÷10kV step 125V
Step time	Duration of measurement per step
Graph R(t)	Enable/Disable Graph R(t)
R(t)	Set of minimum and maximum values of R(t) for graphical screen
R(t) Type	Set of “LIN” (linear) o “LOG” algorithm of graphical screen

Table 7: Setting of internal parameters

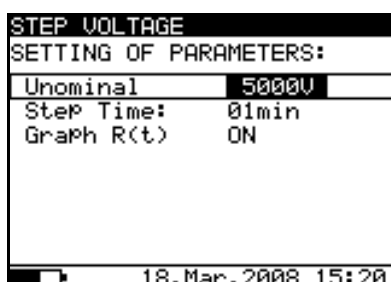

Fig. 36: Setting parameters

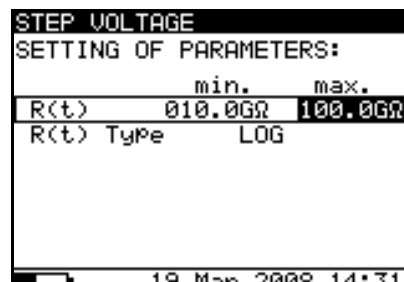

Fig. 37: Setting of graph R(t) parameters

6.7.2 Perform the measurement

1. Switch on the instrument by pressing the **ON/OFF** key
2. Select with arrow keys \blacktriangledown or \blacktriangle the item "STEP VOLTAGE" on main menu and confirm with **SELECT** key. The screen of Fig. 38 is shown by the meter. In case of activation of Graphic R(t) option press arrow keys \blacktriangledown or \blacktriangle to select the graphical screen of Fig. 40



CAUTION

It is not possible to switching mode of presentation when measurement running

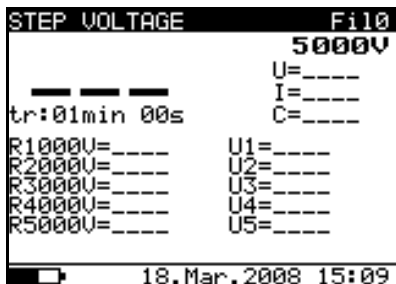

Fig. 38: Initial numerical screen

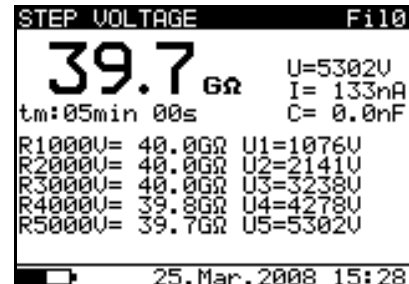

Fig. 39: Numerical screen of result

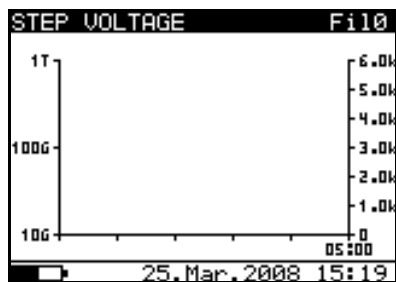

Fig. 40: Initial graphical screen

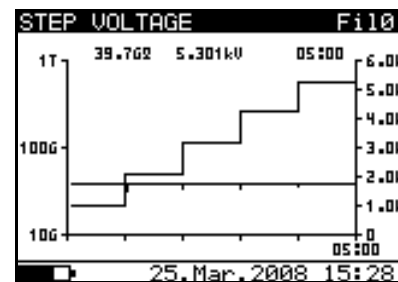

Fig. 41: Graphical screen of result

3. Connect the red part of the Test lead 1 or Test leads 2 (see § 4.2) to the **+OUTPUT** input and the black part of the Test leads 2 (see § 4.2) to the **-OUTPUT** input
4. Connect the tip of Test lead 1 or Test leads 2 (positive) and the black cable of Test leads 2 (negative) to the object on test (see Fig. 24)

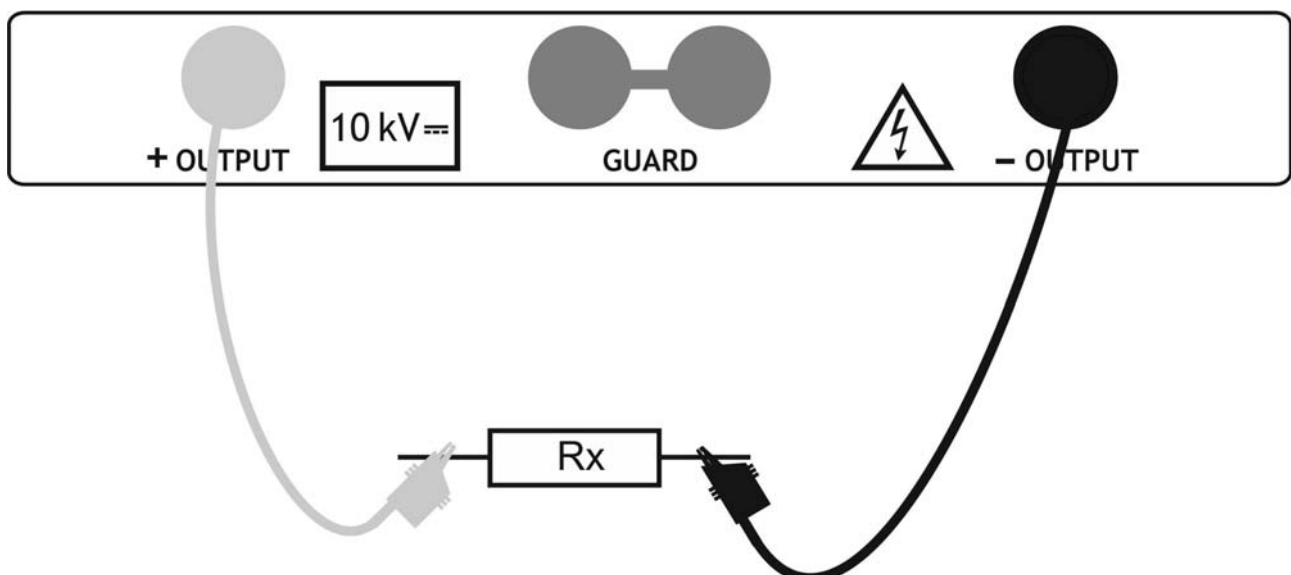

Fig. 42: Connection of instrument for insulation measurement

5. Press **START/STOP** key to activate the insulation measurement
6. Wait for the end of the set Timers. The result of test is shown at display (see Fig. 39 or Fig. 41) with meaning of items described in Table 8
7. Wait for the object under test to discharge
8. For saving the result see § 7

Parameter at display	Description
Fil0 (Fil1, Fil2, Fil3)	Filter type enabled (see § 6.3)
5000V	Set test voltage – step 125 V
U=5302V	Applied test voltage
I=133nA	Applied test current
39.7GΩ	Result of insulation measurement
C=0.0nF	Capacitance of measured object
Tm:05min 00s	Actual test duration
R1000V=40.0GΩ	Last result of 1 st step
R2000V=40.0GΩ	Last result of 2 nd step
R3000V=40.0GΩ	Last result of 3 rd step
R4000V=39.8GΩ	Last result of 4 th step
R5000V=39.7GΩ	Last result of 5 th step
U1=1076V	1 st step voltage
U2=2141V	2 nd step voltage
U3=3238V	3 rd step voltage
U4=4278V	4 th step voltage
U5=5302V	5 th step voltage

Table 8: Meaning of parameters of insulation measurement with step voltage



CAUTION

- Timer information is displayed from the start of the measurement until the completion of each step measurement
- A high-voltage warning symbol appears on the display during the measurement to warn the operator of a potentially dangerous test voltage
- The value of the capacitance is measured during the final discharge of the test object

6.8 WITHSTANDING VOLTAGE TEST

6.8.1 Setting of parameters

1. Switch on the instrument by pressing the **ON/OFF** key
2. Select with arrow keys **▼** or **▲** the item “WITHSTANDING VOLTAGE DC” on main menu and confirm with **SELECT** key. The screen of Fig. 43 is shown by the meter

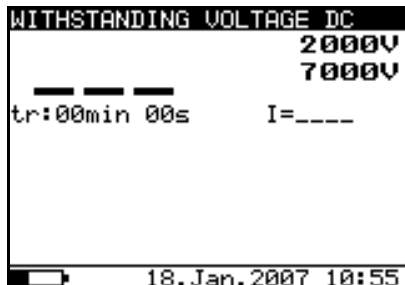

Fig. 43: Initial screen withstanding test

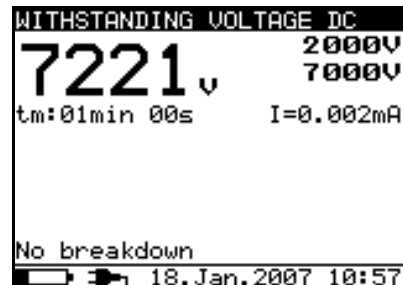

Fig. 44: Final screen withstanding test

3. Press again the **SELECT** key to enter in the setup parameters section. The screen of Fig. 45 is shown by the meter

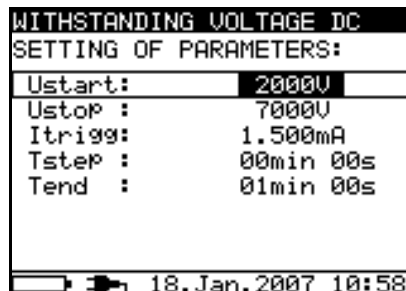

Fig. 45: Setting parameters

4. Use the arrow keys **▼** or **▲** for the selection of parameters. The herewith Table 9 shows the meaning of the measurement parameters
5. Set the values by using the arrow keys **◀** or **▶**. Press **SELECT** key to select possible sub-parameters and repeat the settings
6. Press **ESC** key to save the settings and back to the measurement screen or the **START/STOP** key to exit from the settings menu and activate the test

Parameter	Description
Ustart	Start test voltage – Range 500V ÷ 10kV step 25V
Ustop	Stop test voltage – Range 500V ÷ 10kV step 25V
Itrigg	Set trigger leakage current – Range 0.001mA ÷ 5mA step 10µA
Tstep	Duration of test voltage per one step
Tend	Duration of constant test voltage after reaching stop value

Table 9: Setting of internal parameters

CAUTION



- Tstep and Tend are independent timers. The maximum time for each timer is **30 min 60 s**. Tend begins after the completion of the ramp period. Ramp period can be calculated from:

$$T_{tot-ramp} \cong T_{step} * [(U_{stop} - U_{start}) / 25V]$$
- If Tstep is set to 00min 00s, then the ramp voltage increases by approximately 25 V every 2s

6.8.2 Perform the measurement

1. Switch on the instrument by pressing the **ON/OFF** key
2. Select with arrow keys ▼ or ▲ the item “WITHSTANDING VOLTAGE DC” on main menu and confirm with **SELECT** key. The screen of Fig. 43 is shown by the meter
3. Connect the red part of the Test lead 1 or Test leads 2 (see § 4.2) to the **+OUTPUT** input and the black part of the Test leads 2 (see § 4.2) to the **-OUTPUT** input
4. Connect the tip of Test lead 1 or Test leads 2 (positive) and the black cable of Test leads 2 (negative) to the object on test (see Fig. 46)

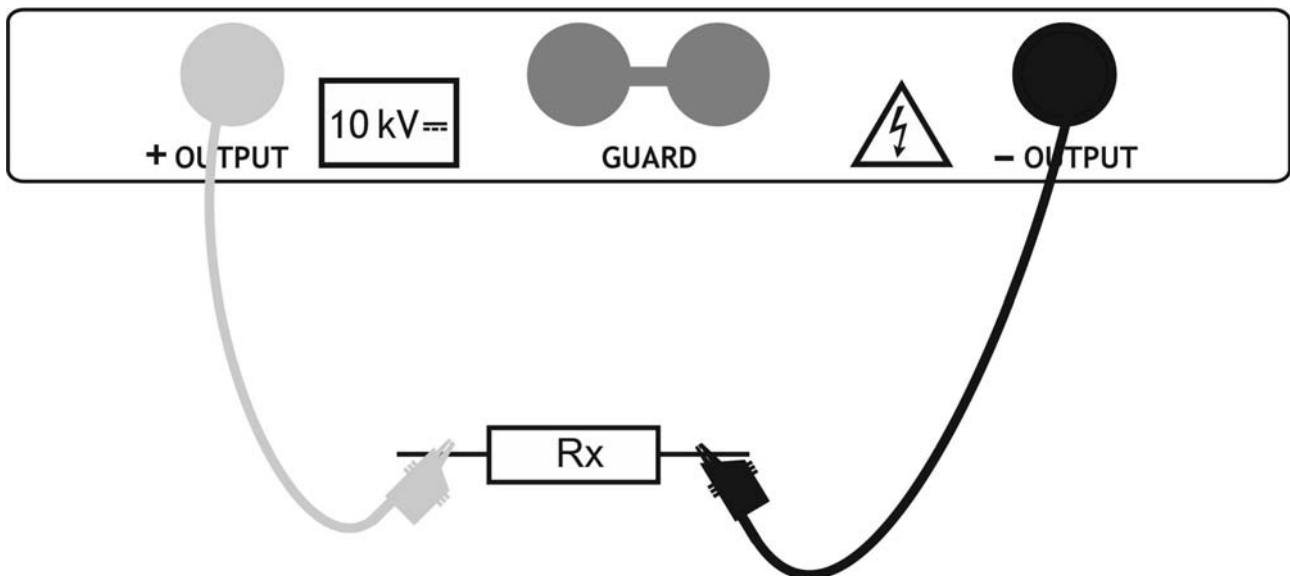

Fig. 46: Connection of instrument for withstanding test

5. Press **START/STOP** key to activate the measurement
6. Wait until the set timers run out or until breakdown occurs. The result of test is shown at display (see Fig. 44) with meaning of items described in Table 10
7. Wait for the object under test to discharge
8. For saving the result see § 7

Parameter at display	Description
2000V	Start test voltage
7000V	Stop test voltage
7221V	Applied test voltage
I=0.002mA	Measured leakage current
Tm:01min 00s	Timer information

Table 10: Meaning of parameters of withstanding test

CAUTION



- Breakdown is detected when the measured current reaches or exceeds the set current level I_{trigg} (see § 6.8.1)
- The timer shows the time needed to complete each step during the measurement and it shows the total measurement period after the completion of the measurement
- A high-voltage warning symbol appears on the display during the measurement to warn the operator of a potentially dangerous test voltage

7 MANAGEMENT OF MEMORY DATA

7.1 SAVING, RECALL AND CLEAR MEASUREMENT RESULTS

SAVING DATA

1. With measurement result displayed press **MEM** key. The screen of Fig. 47 is shown by the instrument

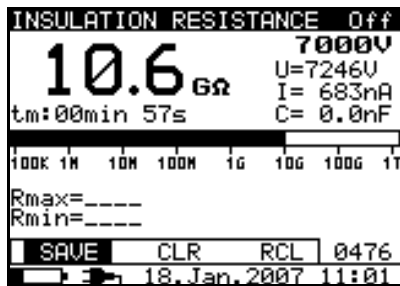

SAVE	CLR	RCL	nnnn
------	-----	-----	------

Fig. 47: Saving data

2. Use the arrow keys ◀ or ▶ and select the “**MEM**” option. The “**nnnn**” number shows the memory location where the data will be saved
3. Press again **MEM** key to confirm the operation. A double acoustic signal is given by the instrument

RECALL SAVED DATA

1. Press **MEM** key, use the arrow keys ◀ or ▶ to select the “**RCL**” option and confirm again with **MEM** key. The last saved data is shown at display
2. Use the arrow keys ▲ or ▼ to select and display the saved data correspondent to the previous memory locations
3. The recalled data with “G” indication means the presence of a graphical screen more than the numerical. Press **SELECT** key to display the graphical screen and **ESC** to return to the numerical one
4. Press **ESC** key to exit from the function and return in measurement mode

CLEAR RESULT

1. For clear all internal memory select the “**Memory clear**” parameter (see § 5.2), press **SELECT** key and confirm with **MEM** key
2. Press **ESC** key to exit from the function
3. For clear the last saved result press **MEM** key, use the arrow keys ◀ or ▶ to select the “**CLR**” option and confirm again with **MEM**. A double acoustic signal is given by the instrument to confirm the operation

8 CONNECTION OF THE INSTRUMENT TO PC

The saved data can be transferred to PC by using the **TeraView** dedicated software included with instrument

TeraView software permits the herewith operations:

- Download data from meter
- Define customized settings on the final report
- Analyze the results of measurements in numerical and graphical screens
- Print the final report
- Export the data in text (TXT) format file

MINIMUM SYSTEM REQUIREMENTS

Pentium III – 500MHz

512 MB RAM

100 MB free space on HD

CD-ROM reader

USB/serial port

Video resolution 800x600

Windows systems: Win2k/XP/Vista/Win7 32 bit and 64 bit platforms

8.1 INSTALLATION OF SOFTWARE AND INITIAL CONFIGURATIONS (WIN XP)

1. Close all the open application on the PC
2. Insert the supplied CD-ROM in the PC reader
3. Launch the “TeraView.exe” file included on CD-ROM and follow the steps to correctly install the TeraView software
4. Switch on the instrument, set the USB mode (see § 5.2) and connect it to the PC by using the supplied USB cable
5. Read the “Instal_USB_neutral.pdf” file inside the “Handbook” folder for the installation of USB driver on the PC
6. Launch the TeraView software
7. Select the command “**Config → Password...**”, type the serial number of meter and the password (which is indicated on the CD-ROM label) and confirm with “Add” (see Fig. 48)

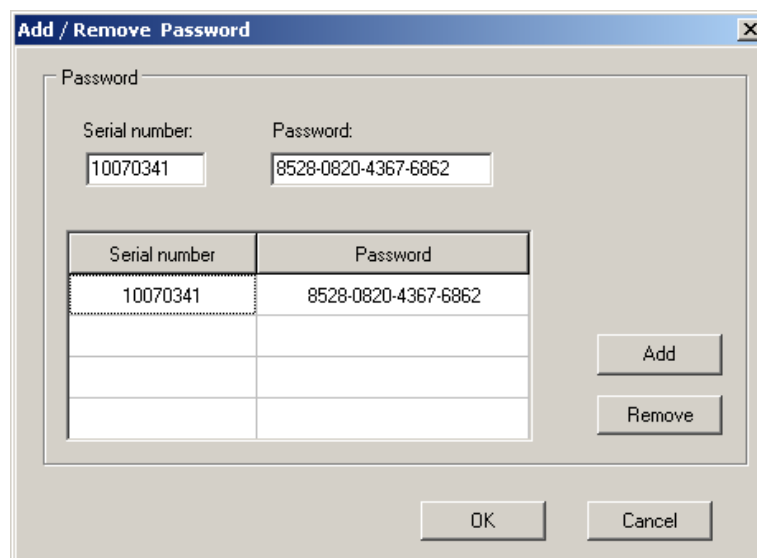

Fig. 48: Insertion of initial password

8. Select the “**Config → COM Port...**” command and click on the “AutoFind” button to start the automatic detection of the instrument (see Fig. 49)

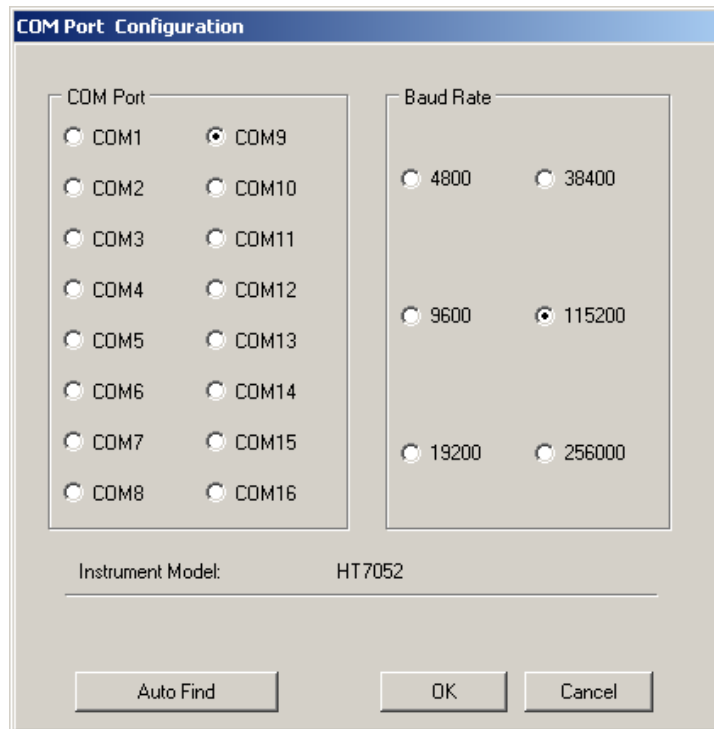

Fig. 49: Connection of the instrument to PC

9. The herewith message means a correct detection of meter by the PC

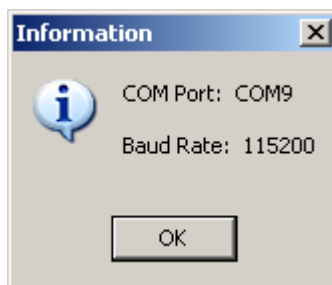

Fig. 50: Correct detection of instrument

10. In case of failed detection of the meter by the PC it should be necessary to re-configure the “virtual” COM serial port associated the USB driver previously installed. The TeraView program can detect automatically serial ports from the **COM1** to the **COM16**. Follow the herewith steps to modify the COM associated to USB driver:

- Right click of mouse on the “**My computer**” icon on the PC desktop and selection of “Properties” item
- “Hardware” folder → “Device Manager” → “Ports (COM & LPT)
- Move on the “USB CDC Serial Port Emulation (COMxx)” item → right click → “Properties”
- Select “Port Settings” → “Advanced...”
- In the COM Port Number list select a “COMxx” among COM1 and COM16
- Confirm all operations, come back to software TeraView and repeat the AutoFind

For any information about the use of TeraView software refer to the help on line of the same program

9 MAINTENANCE

9.1 GENERAL INFORMATION

The instrument You purchased is a precision instrument. During use and storage, carefully observe the recommendations listed in this manual in order to prevent possible damage or dangers during use. Do not use the instrument in environments with high humidity levels or at high temperatures. Do not directly expose to sunlight. Always turn off the instrument after use. Never remove the front panel of the instrument. The instrument don't need any particular maintenance

9.2 REPLACEMENT AND CHARGING BATTERIES

The instrument is power-supplied through internal rechargeable batteries which are recharged from the mains by means of a battery charger integrated in the instrument itself. The symbol "" illuminated in the left bottom part indicates that the batteries are flat and must be recharged



CAUTION

- Connect the instrument to the mains power supply for 20 hours to fully charge batteries. (typical charging current is 600mA). When you charge the batteries for the first time, it normally takes about 3 charge and discharge cycles for the batteries to regain full capacity
- The operator does not need to disconnect the instrument from mains supply after the full recharging period. The instrument can be connected permanently
- The instrument will only work when rechargeable batteries are inside the instrument

In case of batteries replacement follow the herewith steps:



CAUTION

Nominal power supply voltage is 7.2 V DC. Use only six NiMH cells with size equivalent to IEC LR20 (diameter = 33 mm, height = 58 mm)

1. Turn the power off and disconnect any measurement accessories or mains supply cable connected to the instrument before opening the battery cover to avoid electric shock
2. Remove the two screws (see Fig. 1 – Part 15) and open the battery cover
3. Replace all the six batteries with others of the same type respecting the indicated polarity
4. Restore the battery cover
5. Use the appropriate battery disposal methods for your area

9.3 CLEANING THE INSTRUMENT

To clean the instrument, use a soft dry cloth. Never use humid cloths, solvents, water, etc

9.4 END OF LIFE



Warning: the reported symbol indicates that the appliance, the batteries and its accessories must be disposed of separately and treated correctly

10 TECHNICAL SPECIFICATIONS

Accuracy is given as [%rdg + (number of dgt) * resolution] at reference indicated in § 0

INSULATION RESISTANCE MEASUREMENT

Measurement range	Resolution	Accuracy
120kΩ ÷ 999kΩ	1kΩ	±(5.0%rdg + 3dgt)
1.00MΩ ÷ 9.99MΩ	0.01MΩ	
10.0MΩ ÷ 99.9MΩ	0.1MΩ	
100MΩ ÷ 999MΩ	1MΩ	
1.00GΩ ÷ 9.99GΩ	0.01GΩ	
10.0GΩ ÷ 99.9GΩ	0.1GΩ	
100GΩ ÷ 999GΩ	1GΩ	±(15.0% rdg + 3 dgt)
1.00TΩ ÷ 10.00TΩ	0.01TΩ	

FS value of insulation resistance is defined as: RFS = 1GΩ * Utest [V]
 Nominal test voltage: 500 ÷ 10kV DC
 Current capability of test generator: > 1mA
 Short-circuit test current: 5mA ± 10%
 Automatic discharge of tested object: yes

Measurement range test voltage	Resolution	Accuracy
0 ÷ 9999V	1V	±(3.0% rdg + 3V)
≥ 10kV	0.1kV	±3.0% rdg

Nominal test voltage: 500 ÷ 10kV DC programmable in step of 25V
 Accuracy of test voltage: -0 / +10% + 20V
 Output power: 10W max

Measurement range test current	Resolution	Accuracy
0.00 ÷ 9.99nA	0.01nA	±(5.0% rdg + 0.05nA)
10.0 ÷ 99.9nA	0.1nA	
100 ÷ 999nA	1nA	
1.00 ÷ 9.99μA	0.01μA	
10.0 ÷ 9.99μA	0.1μA	
100 ÷ 999μA	1μA	
1.00 ÷ 5.50mA	0.01mA	

Noise current rejection (resistive load)	
Filter option	Maximum current @ 50Hz (mA rms)
Fil0	1.5
Fil1	2.5
Fil2	4.5
Fil3	5

Diagram Test voltage – Resistance

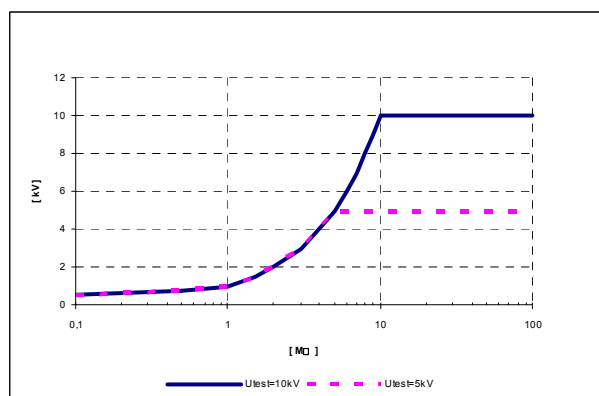

DAR, PI, DD MEASUREMENT

Measurement range	Resolution	Accuracy
0.01 ÷ 9.99	0.01	±(5.0% rdg + 2 dgt)
10.0 ÷ 100.0	0.1	±5.0% dgt

Capacitance range for DD test: 5nF ÷ 50µF

INSULATION MEASUREMENT WITH STEP VOLTAGE

Measurement range test voltage	Resolution	Accuracy
2000 ÷ 9999V	1V	±(3.0% rdg + 3V)
≥ 10kV	0.1kV	±3.0% rdg

 Nominal test voltage: 2000 ÷ 10kV DC programmable in steps of 125V
 Accuracy of test voltage: -0 / +10% + 20V

WITHSTANDING VOLATGE DC

Measurement range test voltage	Resolution	Accuracy
500 ÷ 9999V	1V	±(3.0% rdg + 3V)
≥ 10kV	0.1kV	±3.0% rdg

Measurement range leakage current	Resolution	Accuracy
0.000 ÷ 0.009mA	0.001mA	±(3.0% rdg + 3 dgt)
0.01 ÷ 5.50mA	0.01mA	±3.0% rdg

 Nominal test voltage: 500 ÷ 10kV DC programmable in steps of 25V
 Accuracy of test voltage: -0 / +10% + 20V

AC or DC VOLTAGE

Measurement range	Resolution	Accuracy
0 ÷ 600V	1V	±(3.0% rdg + 4V)

Input impedance: 3MΩ ±10%

Voltage frequency	Resolution	Accuracy
0 e 45.0 ÷ 65.0Hz	0.1Hz	±0.2Hz

 Frequency within 0 and 45Hz: displayed < 45Hz
 Frequency > 65Hz: displayed > 65Hz

CAPACITANCE

Measurement range	Resolution	Accuracy
0.0 ÷ 99.9nF	0.1nF	±(5.0% rdg + 2 dgt)
100 ÷ 999nF	1nF	
1.00 ÷ 50.0µF	0.01µF	

Full-scale value of capacitance is defined as: CFS = 10µF * Utest [kV]

10.1 SAFETY STANDARDS

Instrument safety:	IEC/EN61010-1, IEC/EN61557-2
Measuring accessory safety:	IEC/EN61010-031
Insulation:	double insulation
Protection:	IP44 (closed case)
Polluting level:	2
Overvoltage category:	CAT IV 600V (to earth), max 600V between inputs
Maximum altitude:	2000m (6561ft)

10.2 GENERAL CHARACTERISTICS

Mechanical characteristics

Dimensions (LxWxH): 360 x 330 x 160mm; 14 x 13 x 6in
Weight (with batteries): 5.5kg; 11lb

Power supply

External supply: 90-260V AC, 45-65Hz, 60VA
Internal supply: 6x1.2V rechargeable NiMH battery IEC LR20
Low battery indication: symbol "  " at display
Battery life: approx 4 hours (continuous test on 10kV)

Display

Characteristics: LCD, dot matrix, with backlight (160x116pxl)

Memory

Characteristics: 1000 memory locations

Discharging

Characteristics: each time after the end of test; resistance $425\Omega \pm 10\%$

Connection to PC

RS-232 serial interface: optoinsulated (2400,4800,9600,19200 baud, 1, N)
USB interface: type B standard, 115000 baud

10.3 ENVIRONMENT

Reference temperature: $10^{\circ}\text{C} \div 30^{\circ}\text{C}$; $50^{\circ}\text{F} \div 86^{\circ}\text{F}$
Reference humidity: $40\%\text{RH} \div 60\%\text{RH}$
Operating temperature: $-10^{\circ}\text{C} \div 50^{\circ}\text{C}$; $14^{\circ}\text{F} \div 122^{\circ}\text{F}$
Operating humidity: $<90\%\text{HR}$
Storage temperature: $-20^{\circ}\text{C} \div 70^{\circ}\text{C}$; $-4^{\circ}\text{F} \div 158^{\circ}\text{F}$
Storage humidity: $<90\%\text{HR}$

This instrument complies with the requirements of European Directive on low voltage 2006/95/EC (LVD) and of Directive EMC 2004/108/EC

10.4 ACCESSORIES

- N 1 Test lead red, protection 10kV, 2m
- N 2 Test leads (red/black), basic protection 10kV (double protection 5kV), 2m
- N 2 Alligator clips (red/black), basic protection 10kV (double protection 5kV)
- N 1 Guard test lead green
- N 1 Guard alligator clip green
- N 1 Mains cord
- N 1 USB cable
- N 1 RS-232 cable
- "TeraView" software on CD-ROM
- 6x1.2V rechargeable batteries NiMH type IEC LR20
- User manual
- ISO9000 calibration certificate

11 SERVICE

11.1 WARRANTY CONDITIONS

This instrument is warranted against any material or manufacturing defect, in compliance with the general sales conditions. During the warranty period, defective parts may be replaced. However, the manufacturer reserves the right to repair or replace the product

Should the instrument be returned to the After-sales Service or to a Dealer, transport will be at the Customer's charge. However, shipment will be agreed in advance

A report will always be enclosed to a shipment, stating the reasons for the product's return
Only use original packaging for shipment; any damage due to the use of non-original packaging material will be charged to the Customer

The manufacturer declines any responsibility for injury to people or damage to property

The warranty shall not apply in the following cases:

- Repair and/or replacement of accessories and battery (not covered by warranty)
- Repairs that may become necessary as a consequence of an incorrect use of the instrument or due to its use together with non-compatible appliances
- Repairs that may become necessary as a consequence of improper packaging
- Repairs which may become necessary as a consequence of interventions performed by unauthorized personnel
- Modifications to the instrument performed without the manufacturer's explicit authorization
- Use not provided for in the instrument's specifications or in the instruction manual

The content of this manual cannot be reproduced in any form without the manufacturer's authorization.

Our products are patented and our trademarks are registered. The manufacturer reserves the right to make changes in the specifications and prices if this is due to improvements in technology

11.2 SERVICE

If the instrument does not operate properly, before contacting the After-sales Service, please check the conditions of battery and cables and replace them, if necessary

Should the instrument still operate improperly, check that the product is operated according to the instructions given in this manual

Should the instrument be returned to the After-sales Service or to a Dealer, transport will be at the Customer's charge. However, shipment will be agreed in advance

A report will always be enclosed to a shipment, stating the reasons for the product's return
Only use original packaging for shipment; any damage due to the use of non-original packaging material will be charged to the Customer